

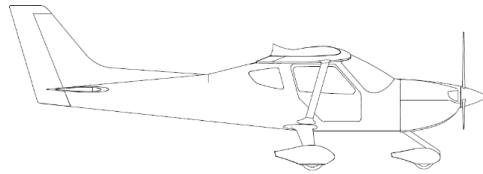

508 Vandenberg Road, Hangar 5
Hondo TX, 78861 USA



Pilot's Operating Handbook

COLT 100

The Colt 100 Aircraft is manufactured by Texas Aircraft Manufacturing and is approved by the FAA regulations as a Special Light-Sport Aircraft under the accepted ASTM consensus standards.

This manual must always be carried on board.

Make: Texas Aircraft Manufacturing, INC

Model: Colt 100

Aircraft Configuration: Single Screen Dynon-VFR- Sterna Propeller- With Parachute-
Rotax 912 ULS2-01

Aircraft Serial Number:

Aircraft Registration Number:



T1-POH-13

Revision NC

11/14/2024

Daniel Maylinch

**Texas Aircraft, Engineering
Manager**

Lucas Falcão

Texas Aircraft, Manager

Philip Jung
Texas Aircraft, QA Manager

This document is owned and controlled by Texas Aircraft.
Requests for changes should be forwarded to any Manager.

	Colt 100	
	PILOT'S OPERATING HANDBOOK	FOREWORD

Record of Manual Revisions

Revision	Date	Description of Revision
NC	11/14/2024	Initial Release. Based on T1-POH-13

T1-POH-13	PAGE	Rev. Date
Revision: NC	3	11/14/2024



List of Effective Pages

FOREWORD	
Page Number	Revision
i	NC
ii	NC
iii	NC
iv	NC
v	NC
vi	NC
vii	NC
viii	NC
ix	NC
x	NC
xi	NC
xii	NC
Section 1	
Page Number	Revision
1-1	NC
1-2	NC
1-3	NC
1-4	NC
1-5	NC
1-6	NC
1-7	NC

Section 2	
Page Number	Revision
2-1	NC
2-2	NC
2-3	NC
2-4	NC
2-5	NC
2-6	NC
2-7	NC
Section 3	
Page Number	Revision
3-1	NC
3-2	NC
3-3	NC
3-4	NC
3-5	NC
3-6	NC
3-7	NC
3-8	NC
3-9	NC
3-10	NC
3-11	NC
3-12	NC

3-13	NC
3-14	NC
3-15	NC
3-16	NC
3-17	NC
Section 4	
Page Number	Revision
4-1	NC
4-2	NC
4-3	NC
4-4	NC
4-5	NC
4-6	NC
4-7	NC
4-8	NC
4-9	NC
4-10	NC
4-11	NC
4-12	NC
4-13	NC
4-14	NC
4-15	NC
Section 5	

T1-POH-13	PAGE	Rev. Date
Revision: NC	4	11/14/2024



Page Number	Revision
5-1	NC
5-2	NC
5-3	NC
5-4	NC
5-5	NC
5-6	NC
5-7	NC
5-8	NC
5-9	NC
Section 6	
Page Number	Revision
6-1	NC
6-2	NC
6-3	NC
6-4	NC
6-5	NC
6-6	NC
6-7	NC
6-8	NC
6-9	NC
6-10	NC
Section 7	
Page Number	Revision

7-1	NC
7-2	NC
7-3	NC
7-4	NC
7-5	NC
7-6	NC
7-7	NC
7-8	NC
7-9	NC
7-10	NC
7-11	NC
7-12	NC
7-13	NC
7-14	NC
7-15	NC
7-16	NC
7-17	NC
7-18	NC
7-19	NC
7-20	NC
7-21	NC
7-22	NC
7-23	NC
7-24	NC

7-25	NC
7-26	NC
7-27	NC
7-28	NC
Section 8	
Page Number	Revision
8-1	NC
8-2	NC
8-3	NC
8-4	NC
8-5	NC
8-6	NC
Section 9	
Page Number	Revision
9-1	NC
9-2	NC
9-3	NC
9-5	NC
9-6	NC
9-7	NC
9-8	NC
9-9	NC
9-10	NC
9-11	NC



Colt 100

PILOT'S OPERATING HANDBOOK

FOREWORD

9-12	NC
9-13	NC
9-14	NC
9-15	NC
9-16	NC
9-17	NC
9-18	NC
9-19	NC
9-20	NC

T1-POH-13	PAGE	Rev. Date
Revision: NC	6	11/14/2024

	Colt 100	
	PILOT'S OPERATING HANDBOOK	FOREWORD

Introduction

This manual, Pilot's Operating Handbook (POH), has been prepared exclusively for the aircraft Colt 100, manufactured by Texas Aircraft Manufacturing. It must be used specifically to fly the Special Light-Sport Aircraft Colt 100, and contains the following sections:

- 1 - General Information
- 2 - Limitations
- 3 - Emergency Procedures
- 4 - Normal Procedures
- 5 – Performance
- 6 – Weight and Balance and Equipment List
- 7 – Description of Airplane and Systems
- 8 – Handling and Servicing
- 9 – Supplements

The aircraft Colt 100 was developed in compliance with the ASTM standards for light-sport aircraft.

The following standards were used to approve this aircraft as a Special Light-Sport Aircraft:

- ✓ F2245, Standard Specification for Design and Performance of a Light Sport Aircraft.
- ✓ F2483, Practice for Maintenance and Development of Maintenance Manuals for Light Sport Aircraft.
- ✓ F2746, Specification for Pilot's Operating Handbook (POH) for Light Sport Aircraft.

In addition, the manufacturing processes and the facility must comply with the QA standards to ensure the quality of the Texas Aircraft Manufacturing products.

- ✓ F3198, Standard Specification for Light Sport Aircraft Manufacturer's Continued Operational Safety (COS) Program.
- ✓ F2972; Standard Specification for Light Sport Aircraft Manufacturer's Quality Assurance System.

The Parachute Rescue System is tested and approved in accordance to the standard below:

- ✓ F2316, Standard Specification for Airframe Emergency Parachutes.

The aim of this manual is to ensure the safe flight and the correct use of the aircraft in accordance with the manufacturer specifications.

The disregard of the operating and technical specifications contained inside this manual can result in injury or loss of life.

This Pilot's Operating Handbook does not substitute adequate flight instruction, airworthiness guidelines or operational air traffic requirements. Also, it does not constitute a guide for basic flight instruction or a flight training manual. This manual must be used only to operate the aircraft.

The pilot is responsible to ensure the aircraft airworthiness, if it is acceptable to the safe flight, respecting the operating limitations, instrument indicators and placards.

Although this manual must always be carried on board, it is not to be used only as a reference in an occasional operation. The pilot must study it completely and regularly to stay current with limitations, performance, procedures, and operational characteristics of the aircraft.

T1-POH-13	PAGE	Rev. Date
Revision: NC	7	11/14/2024

	Colt 100	
	PILOT'S OPERATING HANDBOOK	FOREWORD

A Flight Training Supplement is a separate document and must also be supplied by Texas Aircraft Manufacturing. The Supplement contains the basic flight and maneuvers applicable to this aircraft.

T1-POH-13	PAGE	Rev. Date
Revision: NC	8	11/14/2024

	Colt 100	
	PILOT'S OPERATING HANDBOOK	FOREWORD

Contact Information

Texas Aircraft Manufacturing, INC
 508 Vandenberg Road, Hangar 5
 Hondo, TX 78861
 800-922-2161
 www.texasaircraft.com
 support@texasaircraft.com



Data Location and Contact Information for Recovery of Certification Documentation

Light Aircraft Manufacturers Association (LAMA) establishes a central repository for light sport aircraft (LSA) population and safety-related information. In case Texas Aircraft is unable to support the aircraft model, LAMA can supply the certification documentation. In such an event, please refer to LAMA’s website at <http://lama.bz>.

T1-POH-13	PAGE	Rev. Date
Revision: NC	9	11/14/2024

	Colt 100	
	PILOT'S OPERATING HANDBOOK	FOREWORD

Warnings, Cautions and Notes

The following safety definitions are used in this manual:

WARNING

A WARNING STATEMENT IDENTIFIES A SPECIFIC HAZARD TO PERSONNEL OR DAMAGE TO EQUIPMENT. THE ABSENCE OF THE CORRECT PROCEDURE COULD RESULT IN INJURY AND LOSS OF LIFE.

CAUTION

A CAUTION statement identifies the possible risk of damage to aircraft or equipment if not observed with the correct procedure.

NOTE

A NOTE statement identifies an important or unusual procedure to be emphasized.

T1-POH-13	PAGE	Rev. Date
Revision: NC	10	11/14/2024

	Colt 100	
	PILOT'S OPERATING HANDBOOK	FOREWORD

Table of Contents

- 1 GENERAL INFORMATION
- 2 LIMITATIONS
- 3 EMERGENCY PROCEDURES
- 4 NORMAL PROCEDURES
- 5 PERFORMANCE
- 6 WEIGHT AND BALANCE
- 7 AIRPLANE DESCRIPTION AND SYSTEMS
- 8 HANDLING AND SERVICING
- 9 SUPPLEMENTS

T1-POH-13	PAGE	Rev. Date
Revision: NC	11	11/14/2024



Intentionally left in blank

	Colt 100	SECTION 1
	PILOT'S OPERATING HANDBOOK	GENERAL

1 GENERAL INFORMATION

Table of Contents

1 GENERAL INFORMATION	1
1.1 Introduction to Airplane	2
1.1.1 Type	2
1.1.2 Design	2
1.1.3 Layout	2
1.2 Summary of Performance	3
1.3 List of Abbreviations	5
1.4 Unit Conversions	8

T1-POH-13	PAGE	Rev. Date
Revision: NC	1-1	11/14/2024

	Colt 100	SECTION 1
	PILOT'S OPERATING HANDBOOK	GENERAL

1.1 Introduction to Airplane

1.1.1 Type

This special light-sport aircraft is high-wing, strut-braced, designed for 1 pilot and 1 crew (co-pilot) side-by-side, with fixed landing gear, mixed structure of truss and semi-monocoque, composed of Aluminum Alloy, Chromium-Molybdenum Steel tubes. Powered by one Rotax 912 ULS2-01 engine. The MTOW is 1320lb, including empty aircraft, fuel, crew and baggage (max 44 lb).

1.1.2 Design

The aircraft has a conventional design, resulting in positive control and flight stability. The flaps range is from 0° to 30° and are electrically operated. The nominal aileron deflection is 20° upward and 15° downward. The elevator and rudder have a nominal deflection angle of 25° upward and downward and 20° to the right and left, respectively. The trim tab is deflected by a yoke mounted pilot-controlled thumb switch and an electric servo connected to the trim tab. The main landing gear is equipped with hydraulic brakes and is constructed with an Aluminum Alloy plate. The nose landing gear is free castoring and constructed with Chromium-Molybdenum Steel tubes. To improve the efficiency and performance, all fairings are made of carbon fiber and are specifically made by a hand lay-up and vacuum bag technique.

1.1.3 Layout

The aircraft is composed of the following: power plant, wings, fuselage, tail cone, empennage, flight controls, landing gear, electrical system, avionics and and Parachute Rescue System

T1-POH-13	PAGE	Rev. Date
Revision: NC	1-2	11/14/2024

	Colt 100	SECTION 1
	PILOT'S OPERATING HANDBOOK	GENERAL

1.2 Summary of Performance

Gross Weight	1320 lbs / 600 kg	
Top Speed (Sea Level)	116 KTAS / 119 CAS	
Cruise Speed at 5200 RPM and 4000 ft	107 KTAS / 109 CAS	
Full Fuel Range at 4350 RPM and 4000 ft	831 nm	
Rate of Climb at MTOW	$V_x = 60$ KIAS / 60 CAS	658 fpm (Flap 10) 740 fpm (Retracted)
	$V_y = 64$ KIAS / 65 CAS	684 fpm (Flap 10) 760 fpm (Retracted)
Stall Speed	Flaps Retracted = 44 KIAS / 44 CAS	
	Flaps Extended = 38 KIAS / 39 CAS	
Maximum Demonstrated Crosswind*	$V_{CW} = 17$ kts	
Total Fuel Capacity	31.7 US gal (120 l)	
Total Usable Fuel	30.9 US gal (117 l)	
Approved Types of Fuel**	AVGAS 100 LL (Recommended)	
	MOGAS Premium (91 octane - EN 228 Super Standard, up to 5% ethanol max)	
Maximum Engine Power	Take-off (5800 RPM)	100 hp / 73.5 kW (max 5 minutes)
	Max continuous (5500 RPM)	93 hp / 69.0 kW
Reduction Ratio (crankshaft: propeller shaft)	2.43	

*The maximum crosswind component is obtained when the aircraft is still able to taxi, takeoff, and land while maintaining positive aircraft control.

**For proper fuel choice, SI-912-001 (latest edition) must be observed.

T1-POH-13	PAGE	Rev. Date
Revision: NC	1-3	11/14/2024



	Colt 100	SECTION 1
	PILOT'S OPERATING HANDBOOK	GENERAL

Table 1.2.1 Summary of Performance

WARNING

A FUEL BELOW SPECIFICATIONS CAN CAUSE VAPOR LOCK AND FUEL DETONATION CAUSING POSSIBLE ENGINE BREAKDOWN.

T1-POH-13	PAGE	Rev. Date
Revision: NC	1-4	11/14/2024

	Colt 100	SECTION 1
	PILOT'S OPERATING HANDBOOK	GENERAL

1.3 List of Abbreviations

General Abbreviations	
ASTM	American Society for Testing and Materials
POH	Pilot's Operating Handbook
S-LSA	Special-Light Sport Aircraft
General Airspeed Terminology	
CAS	Calibrated Airspeed*
IAS	Indicated Airspeed
TAS	True Airspeed
V _O	operating maneuvering speed
V _A	design maneuvering speed
V _{AP}	approach speed
V _{CW}	maximum crosswind component
V _{FE}	maximum flap extended speed
V _H	maximum speed in level flight with maximum continuous power
V _{NE}	never exceed speed
V _{NO}	maximum structural cruising speed
V _S	stall speed V _{MC}
V _{S0}	stall speed (flaps fully extended - Landing)
V _{S1}	stall speed (specific configuration - Takeoff)
V _X	speed for best angle of climb
V _Y	speed for best rate of climb
Meteorological Terminology	
hPa	hectopascal pressure unit
IMC	instrument meteorological conditions

T1-POH-13	PAGE	Rev. Date
Revision: NC	1-5	11/14/2024

	Colt 100	SECTION 1
	PILOT'S OPERATING HANDBOOK	GENERAL

ISA	International Standard Atmosphere
OAT	outside air temperature
VFR	visual flight rules
VMC	visual meteorological conditions

T1-POH-13	PAGE	Rev. Date
Revision: NC	1-6	11/14/2024

	Colt 100	SECTION 1
	PILOT'S OPERATING HANDBOOK	GENERAL

Engine Power Terminology	
HP	Horse-power (is the power developed by the engine)
RPM	Revolution Per Minute (is the engine rotation speed)
MFD	Multi-Function Display
Weight and Balance Terminology	
arm _{MLG}	distance between the DATUM and main landing gear
arm _{NLG}	distance between the DATUM and nose landing gear
CG	center of gravity
DATUM	reference point for balance calculation
MTOW	maximum takeoff weight
W _{empty}	total weight of the empty aircraft
W _{MLG}	sum of weight on the main landing gear
W _{NLG}	weight on the nose landing gear

*For standard in this manual the Calibrated Airspeed considers flying at sea level under ISA conditions (15°C, 1013 hPa, 0% humidity).
 Table 1.3.1 List of Abbreviations

T1-POH-13	PAGE	Rev. Date
Revision: NC	1-7	11/14/2024

1.4 Unit Conversions

Length	meter [m]	3.281 feet [ft]
	inch [in]	25.4 millimeters [mm]
Distance	nautical miles [NM]	1.852 kilometers [km]
	nautical miles [NM]	1.15078 miles [mi]
Area	square meter [m ²]	10.764 square feet [ft ²]
Volume	liter [l]	0.264 gallon [us gal]
	cubic inches [in ³]	16.387 cubic centimeter [cm ³]
Weight	kilogram [kg]	2.205 pounds [lb]
Speed	knots [kts]	1.151 miles per hour [mph]
Pressure	bar	14.504 psi
	pound per square feet [lb/ft ²]	4.882 kilogram per square meter [kg/m ²]
Power	kilowatt [kW]	1.341 horse-power [hp]
Moment of Force	kilogram meter [kg.m]	7.233 pound feet [lb.ft]
	kilogram millimeter [kg.mm]	0.0868 pound inch [lb.in]

Table 1.4.1 Unit Conversions

Temperature		Formula
Celsius [°C]	Fahrenheit [°F]	Celsius = 5 ÷ 9 * (Fahrenheit – 32)

Table 1.4.2 Temperature Conversion



Intentionally left in blank

	Colt 100	SECTION 2
	PILOT'S OPERATING HANDBOOK	LIMITATIONS

2 LIMITATIONS

Table of Contents

2 LIMITATIONS

	1
2.1 Airspeed Indicator Markings and Airspeeds	2
2.2 Power Plant Indicator Markings	4
2.3 Service Ceiling	4
2.4 Load Factors	4
2.5 Approved Maneuvers	5
2.6 Prohibited Maneuvers	5
2.7 Total Fuel Capacity, Usable Fuel and Types of Fuel	5
2.8 Maximum Engine Power	6
2.9 Applicable Environmental Limitations	7
2.10 Applicable VFR Night and IMC Limitations	7

T1-POH-13	PAGE	Rev. Date
Revision: NC	2-1	11/14/2024

2.1 Airspeed Indicator Markings and Airspeeds

Marking	Speed Range	Definition
White arc	38 kts – 80 kts	Flap Operating Range
Green arc	44 kts – 108 kts	Normal Operating Range
Yellow arc	108 kts – 132 kts	Operations must be conducted with caution and in smooth air
Red line	132 kts	Never Exceed Speed V _{NE}

Table 2.1.1 Analog Airspeed Indicator Description



Figure 2.1.1 Analog Airspeed Indicator Marks



Airspeeds			
Speed	Description	KIAS	KCAS
V _{SO}	Stall speed (30° - full flaps)	38	37
V _{S1}	Stall speed (10° - flaps)	40	39
V _S	Stall speed (0° - flaps)	44	44
V _{FE}	Maximum flap extended speed	80	81
V _O	Operating maneuvering speed	87	89
V _A			
V _{NO}	Maximum structural cruising speed	108	111
V _{NE}	Never exceed speed	132	136

Table 2.1.2 Airspeeds Description

NOTE

Flight operations are APPROVED with wheel fairings INSTALLED or UNINSTALLED. There is a slight reduction in TAS for flight operations with wheel fairings uninstalled.

2.2 Power Plant Indicator Markings

Instrument	Yellow arc	Green arc	Red arc
Tachometer	1400 - 1800 RPM 5500 - 5800 RPM	1800 - 5500 RPM	0 - 1400 RPM 5800 - 6000 RPM
Fuel Pressure	36 psi - 40.6 psi 46.4 psi - 51 psi	40.6 psi - 46.4 psi	0 psi - 36 psi 51 psi - 53 psi
CHT	-	-13°F - 248°F	248°F - 275°F
Oil Temperature	122°F - 140°F 230°F - 233°F	140°F - 230°F	95°F - 122°F 233°F - 266°F
Oil Pressure	12 psi - 29 psi	29 psi - 73 psi	0 - 12 psi 73 - 102 psi
EGT	0°F - 840°F 1436°F - 1472°F**	840°F - 1436°F	1472°F - 1616°F
Fuel Consumption	0 - 2.2 US gal/h 6.8 - 7.1 US gal	2.2 - 6.8 US gal/h	-
Fuel Tank*	2 - 4 US gal	4 - 16 US gal	0 - 2 US gal

* Each wing fuel tank.

** Temperature range acceptable momentarily during takeoff.

Table 2.2.1 Power Plant Markings

2.3 Service Ceiling

Service Ceiling	14,500 ft / 4420 m
-----------------	--------------------

Table 2.3.1 Service Ceiling

*As described in 14 CFR 91.211, the use of supplemental oxygen is mandatory.

2.4 Load Factors

Load Factor	Flaps Retracted	Flaps Extended
	+ 4g / -2g	+ 2g / -0g

Table 2.4.1 Load Factors

	Colt 100	SECTION 2
	PILOT'S OPERATING HANDBOOK	LIMITATIONS

2.5 Approved Maneuvers

All maneuvers defined as normal flight and/or non-aerobatic maneuvers, including stalls are approved. The approved non-aerobatic maneuvers consist of; lazy eights, chandelles, and steep turns, in which the angle of bank does not exceed 60 degrees.

2.6 Prohibited Maneuvers

All aerobatic maneuvers are prohibited. Intentional spins are prohibited.

WARNING

AEROBATIC MANEUVERS AND INTENTIONAL SPINS ARE PROHIBITED.

2.7 Total Fuel Capacity, Usable Fuel and Types of Fuel

Total Fuel Capacity	31.7 US gal (120 l)
Total Usable Fuel	30.9 US gal (117 l)
Approved Types of Fuel	AVGAS 100LL (Recommended)
	MOGAS premium (91 octane - EN 228 Super Standard, up to 5% ethanol max)

Table 2.7.1 Fuel Info

NOTE

Avoid Steep Turns and Uncoordinated Flight when the fuel quantity level is below $\frac{1}{4}$ in the fuel tank supplying the fuel for engine operation.

T1-POH-13	PAGE	Rev. Date
Revision: NC	2-5	11/14/2024

2.8 Maximum Engine Power

Engine	Power	RPM
Rotax 912 ULS2-01	100 hp / 73.5 kW	Max 5800 (5 minutes limit)
	93 hp / 69.0 kW	Max Continuous 5500

Table 2.8.1 Engine Maximum Power

2.9 Applicable Environmental Limitations

Operation	Limitations
Icing	Prohibited
OAT for Engine Operation	Max = 120°F (50°C)
	Min = -13°F (-25°C)

Table 2.9.1 Environmental Limitations

2.10 Applicable VFR Night and IMC Limitations

Operation	Minimum Required Equipment
VFR Night	Approved according to ASTM F2245-16C, Section A2
IMC	Not Approved

Table 2.10.1 Applicable VFR Night and IMC Limitations

WARNING

FLIGHT OPERATIONS INTO IMC IS PROHIBITED.



Intentionally left in blank

	Colt 100	SECTION 3
	PILOT'S OPERATING HANDBOOK	EMERGENCY PROCEDURES

3 EMERGENCY PROCEDURES

Table of Contents

3 EMERGENCY PROCEDURES	1
3.1 General Information	1
3.2 Airspeeds for Emergency Procedures	2
3.3 Emergency Procedures and Checklists	3
3.3.1 Engine Fire During Start	3
3.3.2 Engine Failure During Takeoff	3
3.3.3 Loss of Engine Power in Flight	6
3.3.4 Forced Emergency Landing without Engine Power	7
3.3.5 Precautionary Landing with Engine Power	8
3.3.6 Fire or Smoke in Flight	8
3.3.7 Loss of Fuel Pressure	10
3.3.8 High Fuel Pressure	10
3.3.9 Loss of Oil Pressure	11
3.3.10 High Oil Pressure	11
3.3.11 Emergency Descent	12
3.3.12 Alternator Failure	12
3.3.13 Overvoltage	12
3.3.14 Inadvertent Spin	13
3.3.15 Inadvertent Icing Encounter	13
3.3.16 Loss of Primary Instruments	13
3.3.17 Loss of Flight Controls	14
3.3.18 Ballistic Parachute Rescue System	15

3.1 General Information

The following definitions are used.

Procedures: An established or official way of completing a task. It is also a series of actions conducted in a certain order or manner.

Checklists: A list of tasks that should be performed in each situation to improve safety and to ensure important tasks are not forgotten (e.g. taxi, takeoff, climb, landing, etc.)

3.2 Airspeeds for Emergency Procedures

Engine Failure during Takeoff	60 KIAS – Best Glide
Engine Failure in Flight	60 KIAS – Best Glide

T1-POH-13	PAGE	Rev. Date
Revision: NC	3-1	11/14/2024

	Colt 100	SECTION 3
	PILOT'S OPERATING HANDBOOK	EMERGENCY PROCEDURES

Precautionary Landing with Engine Power	64 KIAS – V_{AP}
Minimum Airspeed at Touchdown	44 KIAS
Emergency Descent	108 KIAS – V_{NO}

Table 3.2.1 Airspeeds for Emergency Procedures

T1-POH-13	PAGE	Rev. Date
Revision: NC	3-2	11/14/2024

3.3 Emergency Procedures and Checklists

3.3.1 Engine Fire During Start

Procedure: Evacuate the aircraft as soon as practical. Time and safety permitting, complete the checklist below and use the fire extinguisher to extinguish fire if desired.

Engine Fire during Start	
1. Ignition Switch	OFF
2. Fuel Selector Valve	OFF
3. Battery Master Switch	OFF
4. Backup master switch	OFF
5. Throttle	FULL
6. Evacuate	EXTINGUISH FIRE

Table 3.3.1.1 Emergency Procedure Checklist for Engine Fire during Start

3.3.2 Engine Failure During Takeoff

- **Takeoff Roll:**

Procedure: Positive aircraft control is of the utmost importance. Abort takeoff and maintain runway centerline. Complete the checklist below.

Engine Failure During Takeoff Roll	
1. Throttle	IDLE
2. Brakes	AS REQUIRED
3. Flaps	RETRACT
4. Ignition switch	OFF
5. Batt Switch	OFF
6. Backup Battery Master Switch	OFF
7. Fuel Selector Valve	OFF

Table 3.3.2.1 Emergency Procedure Checklist for Engine Failure during Takeoff Roll

	Colt 100	SECTION 3
	PILOT'S OPERATING HANDBOOK	EMERGENCY PROCEDURES

NOTE

When the Master Switches are off, all electronic instruments may not be operational. The flight will be operated only by backup instruments.

T1-POH-13	PAGE	Rev. Date
Revision: NC	3-4	11/14/2024

	Colt 100	SECTION 3
	PILOT'S OPERATING HANDBOOK	EMERGENCY PROCEDURES

- **Immediately After Takeoff:**

Procedure: Positive aircraft control is of the utmost importance. Land straight ahead if available runway remains. If there is no remaining runway, returning to the runway may be inadvisable. When identifying the best place to land, consider small changes in heading (up to 30° to the right or left) and plan an approach. Priority at touchdown is flaps full at the minimum recommended airspeed (44 KIAS). Complete the checklist below.

Engine Failure Immediately After Takeoff	
1. Airspeed	60 KIAS – BEST GLIDE
2. Electric Fuel Pump	ON
3. Throttle	FULL
4. Flaps	FULL
5. Ignition Switch	OFF
6. Fuel Selector Valve	OFF
7. Battery Master Switch	OFF
8. BCKP PWR Master Switch (if installed)	OFF
9. Doors	UNLOCK and UNLATCH
10. Touchdown	44 KIAS

Table 3.3.2.2 Emergency Procedure Checklist for Engine Failure Immediately After Takeoff

T1-POH-13	PAGE	Rev. Date
Revision: NC	3-5	11/14/2024

- **After Takeoff Above 500ft:**

Procedure: Positive aircraft control is of the utmost importance. Consider an immediate return to the runway but realize the best place to land may be in front, besides, or behind the aircraft position. Plan approach. Priority at touchdown is full flaps at the minimum recommended airspeed (44 KIAS). Complete the checklist below.

Engine Failure After Takeoff	
1. Airspeed	60 KIAS – BEST GLIDE
2. Electric Fuel Pump	ON
3. Throttle	FULL then IDLE
4. Fuel Selector Valve	SWITCH (LH or RH)
5. Ignition Switch	START (Starter Engage for Max 10 Seconds) (If no restart then OFF)
6. Fuel Selector	OFF
7. Flaps	FULL (When Landing Assured)
8. Battery Master Switch	OFF
9. BCKP PWR Master Switch (if installed)	OFF
10. Doors	UNLOCK and UNLATCH
11. Touchdown	44 KIAS
1. Airspeed	60 KIAS – BEST GLIDE
2. Electric Fuel Pump	ON

Table 3.3.2.3 Emergency Procedure Checklist for Engine Failure after Takeoff

3.3.3 Loss of Engine Power in Flight

- **Partial Loss of Engine Power:**

Procedure: In case of partial loss of engine power, the pilot should confirm if the engine power is sufficient for level flight. If engine power is sufficient, land as soon as practical. If engine power cannot maintain level flight, use the engine power available to proceed to the best place to land. If needed proceed to Section 3.3.4 “Forced Emergency Landing without Engine Power” or Section 3.3.5 “Precautionary Landing with Engine Power.”

- **Total Loss of Engine Power with Engine Restart in Flight:**

Procedure: Positive aircraft control is of the utmost importance. Realize the best place to land may be in front, besides, or behind the aircraft position. Plan to approach into the headwind if able. If possible, attempt to restart the engine in flight. Between attempts, switch the fuel valve selector from RH to LH. Complete the checklist below.

Engine Restart in Flight

1. Airspeed	60 KIAS – BEST GLIDE
2. Electric Fuel Pump	ON
3. Throttle	FULL then IDLE
4. Fuel Selector Valve	SWITCH (RH or LH)
5. Carburetor Heat (if installed)	AS REQUIRED

If restart fails, proceed to next section 3.3.4 "Forced Emergency Landing without Engine Power". If engine restarts, land as soon as practical

Table 3.3.3.1 Emergency Procedure Checklist for Engine Restart in Flight

NOTE

The glide ratio is 11.3:1 with power at idle and 9.9:1 with power off. Therefore, glide will be 1.86 NM with power at idle or 1.62 NM with power off for every 1000 feet of altitude loss in no wind conditions.

3.3.4 Forced Emergency Landing without Engine Power

Procedure: Positive aircraft control is of the utmost importance. Realize the best place to land may be in front, besides, or behind the aircraft position. Plan to approach into the headwind if able. Priority at touchdown is full flaps at the minimum recommended airspeed (44 KIAS). Complete the checklist below.

Forced Landing without Engine Power

1. Airspeed	60 KIAS – BEST GLIDE
2. Communication/Transponder	DECLARE EMERGENCY
3. ELT Remote Switch	ON
4. Safety Harnesses	SECURE
5. Ignition Switch	OFF
6. Fuel Selector Valve	OFF
7. Flaps	FULL (When Landing Assured)
8. Battery Master Switch	OFF
9. BCKP PWR Master Switch (if installed)	OFF
10. Doors	UNLOCK and UNLATCH

	Colt 100	SECTION 3
	PILOT'S OPERATING HANDBOOK	EMERGENCY PROCEDURES

11. Touchdown

INTO WIND (44 KIAS)

It may be advisable to consider the Ballistic Parachute Rescue System (if installed). If desired, proceed to Section 3.3.16 "Ballistic Parachute Rescue System"

Table 3.3.4.1 Emergency Procedure Checklist for Forced Landing without Engine Power

3.3.5 Precautionary Landing with Engine Power

Procedure: Positive aircraft control is of the utmost importance. Realize the best place to land may be in front, besides, or behind the aircraft position. Plan to approach into the headwind if able. Priority at touchdown is full flaps at the minimum recommended airspeed (44 KIAS). Complete the checklist below.

Precautionary Landing with Engine Power	
1. ELT Remote Switch	ON
2. Communication	DECLARE EMERGENCY
3. Place to Land	FLYOVER and SURVEY
4. Safety Harnesses	SECURE
5. Fuel Selector Valve	FULLEST TANK
6. Flaps	FULL (When Landing Assured)
7. Battery Master Switch	OFF
8. BCKP PWR Master Switch (if installed)	OFF
9. Ignition Switch	BOTH
10. Doors	UNLOCK and UNLATCH
11. Approach Airspeed	64 KIAS – V _{AP}
12. Touchdown	INTO WIND (44 KIAS)
13. Ignition Switch	OFF
1. ELT Remote Switch	ON

Table 3.3.5.1 Emergency Procedure Checklist for Precautionary Landing with Engine Power

NOTE

When the Master Switches are off, all electronic instruments may not be operational. The flight will be operated only by backup instruments.

T1-POH-13	PAGE	Rev. Date
Revision: NC	3-8	11/14/2024

	Colt 100	SECTION 3
	PILOT'S OPERATING HANDBOOK	EMERGENCY PROCEDURES

3.3.6 Fire or Smoke in Flight

- **Engine Fire in Flight:**

Procedure: Positive aircraft control is of the utmost importance. If possible, maintain a KIAS that will provide an incombustible fuel/air mixture. Plan to approach into the headwind if able. Priority at touchdown is full flaps at the minimum recommended airspeed (44 KIAS). Complete the checklist below.

Engine Fire in Flight	
1. Ignition Switch	OFF
2. Fuel Selector Valve	OFF
3. Throttle	FULL
4. Battery Master Switch	OFF
5. BCKP PWR Master Switch (if installed)	OFF
6. Airspeed (Emergency Decent)	132 KIAS – V_{NE} (Smooth Air) 108 KIAS – V_{NO} (Turbulent Air)
1. Ignition Switch	OFF
2. Fuel Selector Valve	OFF
3. Throttle	FULL
Proceed to section 3.3.9 “Emergency Descent” and then section 3.3.4 “Forced Emergency Landing without Engine Power”.	

Table 3.3.5.1 Emergency Procedure Checklist for Engine Fire in Flight

T1-POH-13	PAGE	Rev. Date
Revision: NC	3-9	11/14/2024

	Colt 100	SECTION 3
	PILOT'S OPERATING HANDBOOK	EMERGENCY PROCEDURES

Cabin Fire/Smoke in Flight:

Procedure: Positive aircraft control is of the utmost importance. Continue flight without electrical power. Land as soon as practical. Complete the checklist below.

Cabin Fire in Flight	
1. Battery Master Switch	OFF
2. BCKP PWR Master Switch (if installed)	OFF
3. Vents	CLOSE
4. Fire Extinguisher	EXTINGUISH FIRE
5. Vents	OPEN
1. Battery Master Switch	OFF
2. BCKP PWR Master Switch (if installed)	OFF

Table 3.3.5.1 Emergency Procedure Checklist for Cabin Fire in Flight

3.3.7 Loss of Fuel Pressure

If the fuel pressure is below the minimum operating pressure of 2.2 psi, follow the procedure below.

Loss of Fuel Pressure	
1. Main and Auxiliary Fuel Pump	ON

Procedure: Reduce engine power to a minimum that maintains level flight. Land as soon as practical. After the auxiliary fuel pump is turned on it is possible that the pressure may exceed the maximum operating pressure of 51 psi, in this situation keep the auxiliary fuel pump ON.

T1-POH-13	PAGE	Rev. Date
Revision: NC	3-10	11/14/2024

	Colt 100	SECTION 3
	PILOT'S OPERATING HANDBOOK	EMERGENCY PROCEDURES

3.3.8 High Fuel Pressure

If the fuel pressure is above the maximum operating pressure of 51 psi, follow the procedure below.

High Fuel Pressure	
1. Auxiliary Fuel Pump	OFF

Procedure: If the auxiliary fuel pump is turned OFF and the fuel pressure remains above the operational pressure of 51 psi, reduce engine power to a minimum that maintains level flight. Land as soon as practical.

3.3.9 Loss of Oil Pressure

If the oil pressure is below the minimum operating pressure of 29 psi, follow the procedure below.

Procedure: Reduce engine power to a minimum that maintains level flight. Land as soon as practical. A precautionary landing may be advisable. See Section 3.3.5 "Precautionary Landing with Engine Power."

3.3.10 High Oil Pressure

If the oil pressure is above the maximum operating pressure of 73 psi, follow the procedure below.

Procedure: Reduce engine power to a minimum that maintains level flight. Land as soon as practical.

T1-POH-13	PAGE	Rev. Date
Revision: NC	3-11	11/14/2024

	Colt 100	SECTION 3
	PILOT'S OPERATING HANDBOOK	EMERGENCY PROCEDURES

3.3.11 Emergency Descent

Procedure: Set throttle to idle. Pitch attitude down to start an emergency descent. Do not exceed V_{NE} (132 KIAS) in smooth air or V_{NO} (108 KIAS) in turbulent air. Upon reaching an altitude no less than 500ft AGL transition to land or level off. Decrease the airspeed and, if needed, follow Section 3.3.4 "Forced Emergency Landing without Engine Power."

3.3.12 Alternator Failure

Procedure: Shut down all non-essential electronics and land as soon as practical. If equipped with a dual alternator system, turn the alternator switch to STBY. Continue flight normally on STBY.

3.3.13 Overvoltage

Procedure: Shut down all non-essential electronics and land as soon as practical. If equipped with the dual alternator system, turn the alternator switch to STBY. Continue flight normally on STBY. If STBY does not resolve the overvoltage condition, turn the alternator switch to OFF. Shut down all non-essential electronics and land as soon as practical.

NOTE

The maximum permissible voltage in the normal operation range is 14.2 V.

T1-POH-13	PAGE	Rev. Date
Revision: NC	3-12	11/14/2024

3.3.14 Inadvertent Spin

A spin is caused by uncoordinated flight and characterized by a nose down attitude with continuous rotation about the vertical axis. The spin recovery is below.

Procedure: Set throttle to idle. Maintain a neutral position on the control yoke. Apply full rudder pressure in the opposite direction of the spin until the spin stops. Neutralize the rudder; slowly increase pitch to avoid overloading the wings and preventing a stall. Return to level flight, and cruise configuration.

Spin Recovery	
1. Throttle	IDLE
2. Yoke	NEUTRAL
3. Rudder	OPPOSITE of TURN
4. Pitch	SLOWLY INCREASE

Table 3.3.12.1 Emergency Procedure Checklist for Spin Recovery

WARNING

THIS AIRCRAFT IS NOT APPROVED FOR INTENTIONAL SPINS.

3.3.15 Inadvertent Icing Encounter

Procedure: Change altitude and/or heading to exit the icing conditions. Increase power setting/RPM if able.

WARNING

THIS AIRCRAFT IS NOT APPROVED TO FLY INTO KNOWN ICING CONDITIONS.

	Colt 100	SECTION 3
	PILOT'S OPERATING HANDBOOK	EMERGENCY PROCEDURES

3.3.16 Loss of Primary Instruments

Procedure: In case of loss of primary instruments, control the aircraft using the secondary backup instruments. Land as soon as practical.

3.3.17 Loss of Flight Controls

- **Loss of Elevator:**

Procedure: Reduce airspeed to 64 KIAS. Use the trim tab combined with engine power to adjust the aircraft attitude. Land as soon as practical and declare an emergency.

- **Loss of Aileron:**

Procedure: Reduce airspeed to 64 KIAS. Use the rudder to keep the wings level. The aircraft should fly in a skid or slip condition, but in control. Land as soon as practical and declare an emergency.

- **Loss of Rudder:**

Procedure: Reduce airspeed to 64 KIAS. Coordinate aileron and engine power to keep the aircraft in control. Land as soon as practical and declare an emergency.

- **Loss of Trim Tab:**

Procedure: Reduce airspeed to V_A or below. Likely, use of control pressures will be necessary to maintain positive aircraft control. In the event of a runaway trim, pull out the trim circuit breaker to disconnect the electronic trim system. With the trim system disconnected, note the trim tab will remain in the last position prior to deactivation. This is the trim tab position for the remainder of the flight. Again, use of control pressures will likely be necessary to maintain positive aircraft control. The plane can be flown at a KIAS at or below V_A and landed without much control force in a full up or down trim position using necessary control pressures. Land as soon as practical and declare an emergency.

T1-POH-13	PAGE	Rev. Date
Revision: NC	3-14	11/14/2024

	Colt 100	SECTION 3
	PILOT'S OPERATING HANDBOOK	EMERGENCY PROCEDURES

3.3.18 Ballistic Parachute Rescue System

This aircraft may be equipped with a Ballistic Parachute Rescue System. In the event of the circumstances described below, with risk of life, activating the parachute system may be advisable.

Circumstances that may warrant the use of the Parachute System:

- Structural failure.
- Loss of aircraft control.
- Pilot incapacitation due to health condition.
- Engine failure over unfavorable terrain.
- Engine failure in unfavorable flight conditions.

Procedure: Make sure the safety harnesses are secure, and pin is removed. Be sure that the aircraft is at or above the minimum activation altitude of 1,000 ft AGL and at an airspeed less than V_{NE} (132 KIAS). Then, pull the parachute launching handle. The pull force on the handle to activate the parachute is about 11 kgf of force.

Refer to Galaxy GRS manual for GRS 6/600 SD for operating and additional information <https://www.galaxysky.cz/manuals-s16-en>

WARNING

ONLY PULL THE PARACHUTE LAUNCHING HANDLE WITH THE SAFETY HARNESSSES FASTENED. THE PARACHUTE OPENING CAN REACH UP TO 7 GS.

T1-POH-13	PAGE	Rev. Date
Revision: NC	3-15	11/14/2024



Intentionally left in blank

	Colt 100	SECTION 4
	PILOT'S OPERATING HANDBOOK	NORMAL PROCEDURES

4 NORMAL PROCEDURES

Table of Contents

4 NORMAL PROCEDURES

	1
4.1 Preflight Checklist	2
4.1.1 Verification of Fluids	4
4.2 Engine Start	5
Taxi	6
4.3 Takeoff	7
4.4 Cruise	9
4.5 Before Landing	10
4.6 Balked Landing (Go Around)	10
4.6.1 Sideslip	10
4.7 After Landing	10
4.8 Engine Shut Down	11

T1-POH-13	PAGE	Rev. Date
Revision: NC	4-1	11/14/2024

4.1 Preflight Checklist

Before each flight, an exterior pre-flight inspection must be done according to the checklist below.

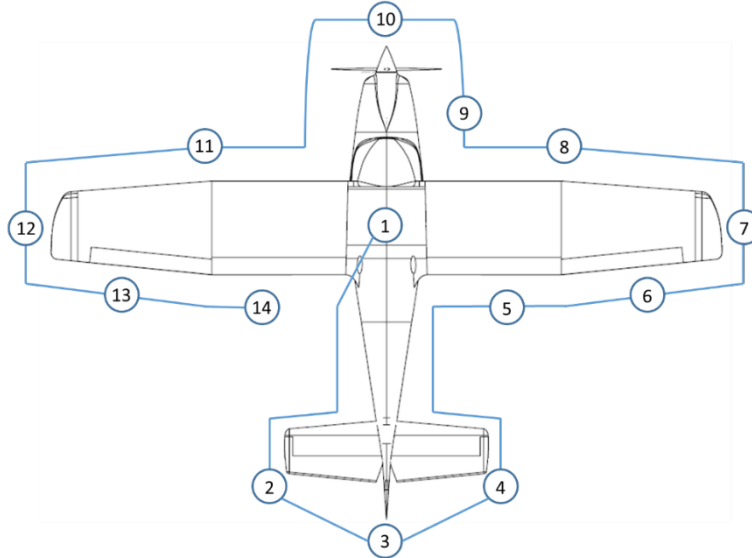



Figure 4.1.1 Preflight Inspection

- **Preflight Inspection Procedures:**

- ① Remove all covers and control locks. Perform a walkaround of the aircraft verifying functionality of the lights required for the flight. Confirm all required documentation for airworthiness is present.
- ② Check the integrity of the empennage and elevator. Check for cracks on the skins. Check the hinges and hardware attachment points. Check the elevator for freedom of movement. Inspect the attachments of the elevator push-pull rod through the inspection window on the lower left side of the empennage.
- ③ Check the integrity of the empennage and rudder. Check for cracks on the skins. Check the hinges and hardware attachment points. Check the rudder for freedom of movement. Check the trim tab.
- ④ Check the integrity of the empennage and elevator. Check for cracks on the skins. Check the hinges and hardware attachment points. Check the elevator for freedom of movement.
- ⑤ Check that the static port on the right side of the fuselage is clear from obstruction. Check the condition and security of the antennas on the top and bottom of the fuselage from the right side. Check the fuselage for damage and cracks. Check the integrity of the right flap. Check for cracks on the skin. Check the hinges and hardware attachment points.
- ⑥ Check the integrity of the right aileron. Check for cracks on the skin. Check the aileron for freedom of movement. Check the hinges and hardware attachment points.
- ⑦ Check the right-wing tip structure for damages and cracks. Verify the right-wing tank fuel vent is clear from obstruction.

	Colt 100	SECTION 4
	PILOT'S OPERATING HANDBOOK	NORMAL PROCEDURES

⑧ Check the right-wing leading edge surface for damages and cracks. Check if the fuel filler cap is secure and the cap locking lever is aft for streamline purposes. Check the wing strut for condition and security. Sump the fuel from the right-wing main fuel tank drain under the wing. Check the integrity of the main landing gear. Check the integrity and installation of the main landing gear fairing. Check the main wheel and tire condition. Check the main wheel tire pressure for 35 psi. (See section 4.1.1 “Verification of Fluids” for more information).

⑨ Drain the fuel on the firewall gascolator valve. Verify the engine oil and coolant levels are adequate for flight operation and the caps are secure. Check for any oil, coolant and fuel leaks. Close and secure the cowling. (See section 4.1.1 “Verification of Fluids” for more information).

WARNING

RISK OF BURNING AND SCALDINGS WHEN CONDUCTING ENGINE CHECKS.

⑩ Check the integrity of the propeller and spinner. Check that the ram air inlets are clear from obstruction. Check that the oil cooler and radiator are clear from obstruction. Check the integrity and installation of the nose gear fairing. Check the nose wheel and tire condition. Check the nose tire pressure for 25 psi.

⑪ Verify the pitot tube is clear from obstruction. Check the left-wing leading edge surface for damages and cracks. Check if the fuel filler cap is secure and the cap locking lever is aft for streamline purposes. Check the wing strut for condition and security. Sump the fuel from the left-wing main fuel tank drain under the wing. Check the integrity of the main landing gear. Check the integrity and installation of the main landing gear fairing. Check the main wheel and tire condition. Check the main wheel tire pressure for 35 psi. (See section 4.1.1 “Verification of Fluids” for more information)

CAUTION

Do not blow inside the pitot tube to clear the instrument and line. This will cause damage to the system.

⑫ Check the left-wing tip structure for damages and cracks. Verify the left-wing tank fuel vent is clear from obstruction.

T1-POH-13	PAGE	Rev. Date
Revision: NC	4-3	11/14/2024

	Colt 100	SECTION 4
	PILOT'S OPERATING HANDBOOK	NORMAL PROCEDURES

⑬ Check the integrity of the left aileron. Check for cracks on the skins. Check the aileron for freedom of movement. Check the hinges and hardware attachment points.

⑭ Check that the static port on the left side of the fuselage is clear from obstruction. Check the condition and security of the antennas on the top and bottom of the fuselage from the left side. Check the fuselage for damage and cracks. Check the integrity of the left flap. Check for cracks on the skin. Check the hinges and hardware attachment points.

4.1.1 Verification of Fluids

- **Fuel:**

Check the fuel before each flight and after refueling. Allow the fuel to settle for a few minutes after refueling and do not move the aircraft before sumping the main fuel tanks. There are three fuel drain valves. One drain is located on the lower right hand firewall on the gascolator (reference drain placard on right side of cowling) and the other two drains are located on the bottom inboard of each wing. Sump the fuel of each drain checking for the presence of water or debris in the fuel sample drain cup. Sump the fuel until it is completely free of water and debris. Start draining the fuel for each wing using the fuel sump and a fuel cup to check for water or debris, then certify that the fuel selector valve is in the LH or RH position, finish draining the gascolator valve on firewall, use a fuel cup to check for water or debris.

- **Oil:**

To check the oil, ALWAYS rotate the propeller clockwise in the normal direction of rotation. Remove the cap to the oil reservoir. Rotate the propeller to pressurize the system allowing the oil in the engine to flow into the reservoir. Continue rotating the propeller until a gurgling sound is heard. The oil level in the reservoir is now ready to check. Read oil level on the dipstick.

- **Coolant:**

<p>CAUTION</p> <p>Verify coolant level in the overflow bottle mounted on the firewall, fill as required to be between the max and min mark indicated on the plastic bottle.</p>
--

T1-POH-13	PAGE	Rev. Date
Revision: NC	4-4	11/14/2024

4.2 Engine Start

- Before Engine Start:**

Before Engine Start	
1. Seats	ADJUSTED and LOCKED
2. Safety Harnesses	FASTENED and SECURE
3. Brakes	FIRM and EVEN
4. Throttle	CRACKED 1/2"
5. Fuel Selector Valve	LH or RH
6. Circuit Breakers	VERIFY
7. Battery Master Switch	ON
8. BCKP PWR Master Switch (if installed)	ON
9. EFIS Switch (if installed)	ON
10. Main Fuel Pump	ON
11. LANE A and LANE B	ON
12. Batt Switch	ON
13. Start Power Switch	ON
14. Warning Lamps	ILLUMINATE and TURN OFF after 3 SECONDS
15. Fuel Pressure	AT LEAST 43.5 PSI
16. Ignition Switch	START (Release when engine starts)
17. Start Power Switch	OFF (When engine starts)

Table 4.2.1 Before Engine Start Procedure

WARNING

DO NOT, UNDER ANY CIRCUMSTANCES, START THE ENGINE IF THE PROPELLER AREA IS NOT CLEAR.



CAUTION

Continuous starter activation for maximum of 10 seconds only. This procedure avoids overheating the starter motor. If the engine does not start, release the ignition switch, then wait 2 minutes and repeat the start procedure.

• **After Engine Start:**

After Engine Start	
1. Oil Pressure	VERIFY 29 - 73 PSI
2. Throttle	2000 RPM*
3. Engine Instruments	Green Arc
4. Alternator Switch (if dual alternator)	ON (Charging)
5. Master Avionics Switch	ON
6. Circuit Breakers	VERIFY

*Do not exceed 2500 RPM until the oil temperature is 120°F or higher. Warm up may be conducted at 2300 RPM.

Table 4.2.2 After Engine Start Procedure

NOTE

After starting the engine, the warning lamps must be off.

o Taxi

● **Before Taxi:**

Before Taxi	
1. Lights	AS REQUIRED
2. ELT Remote Switch	ARM/OFF
3. Radios	SET
4. Transponder	SET
5. Fuel Quantity	SET and VERIFY
6. Flight Instruments	SET

Table 4.3.1 Before Taxi Procedure

● **Taxi:**

Taxi	
1. Oil Temperature	VERIFY*
2. Brakes	VERIFY
3. Flight Instruments	VERIFY
*Do not exceed 2500 RPM until the oil temperature is 120°F or higher.	

Table 4.3.2 Taxi Procedure

NOTE

The minimum turn radius is 20 ft or 5.95 m.

4.3 Takeoff

● **Before Takeoff:**

Before Takeoff	
1. Brakes	HOLD
2. Flight Controls	FREE and CORRECT
3. Throttle	4000 RPM*
4. Ignition Switch	CHECK RPM DROP (Must Not Exceed 250 RPM)

	Colt 100	SECTION 4
	PILOT'S OPERATING HANDBOOK	NORMAL PROCEDURES

	VERIFY MAX RPM DIFFERENCE (Must Not Exceed 115 RPM Between Circuits)
5. Main and Auxiliary Fuel Pump	ON
6. Engine Instruments	CHECK
7. Throttle	VERIFY IDLE Then 2000 RPM
8. Auxiliary Fuel Pump	OFF for 5 SECONDS VERIFY FUEL PRESSURE THEN ON
9. Main Fuel Pump	OFF for 5 SECONDS VERIFY FUEL PRESSURE THEN ON
10. Transponder	SET
11. Radios	SET
12. Flight Instruments	VERIFY
13. Lights	AS REQUIRED
14. Fuel Selector Valve	VERIFY
15. Trim Tab	SET for TAKEOFF
16. Flaps	SET for TAKEOFF (0° - 10°)
17. Parachute Launching Handle	UNLOCKED and AVAILABLE**
18. Doors	LOCKED and LATCHED

*Do not exceed 2500 RPM until the oil temperature is 120°F or higher.
 **Do not activate Ballistic Parachute Rescue System below 1000ft AGL..

Table 4.4.1 Before Takeoff Procedure

● **Takeoff:**

Takeoff	
1. Flaps	SET for TAKEOFF (0° - 10°)
2. Trim Tab	SET for TAKEOFF
3. Brakes	RELEASED
4. Throttle	FULL (5800 RPM Maximum 5 Minute Limit) (5500 RPM Maximum Continuous)
5. Rotation speed	50 KIAS
6. Airspeed	64 KIAS – V _Y 60 KIAS – V _X
7. Lights	AS REQUIRED
8. Auxiliary Fuel Pump	OFF at safe altitude

Table 4.4.1 Takeoff Procedure

T1-POH-13	PAGE	Rev. Date
Revision: NC	4-8	11/14/2024

	Colt 100	SECTION 4
	PILOT'S OPERATING HANDBOOK	NORMAL PROCEDURES

- **Short Field Takeoff:**

Procedure: With 10° of flaps, start the takeoff by holding the brakes and at the same time increase the throttle to full. Verify engine instruments are within parameters and release the brakes. Rotate aircraft at 50 KIAS and climb out at 60 KIAS – V_x until the aircraft is clear of all obstacles. Then, proceed with a normal takeoff.

- **Soft Field Takeoff:**

Procedure: With 10° of flaps, no brakes, keep aircraft moving during full throttle application and acceleration. Maintain back pressure on the yoke to take the weight off the nose wheel. The aircraft should become airborne prematurely. Maintain ground effect until airspeed increases to 60 KIAS – V_X. Then, proceed with a normal takeoff.

NOTE

Airspeeds higher than V_x or V_y provide better engine cooling, greater control authority, and better forward visibility.

4.4 Cruise

Cruise	
1. Throttle	4500 RPM – 5500 RPM (Normal 4800 RPM – 5200 RPM)
2. Engine Instruments	VERIFY
3. Fuel Quantity	VERIFY
4. Fuel Selector Valve	RH or LH*
*Monitor and manually switch fuel selector valve RH or LH to properly manage fuel imbalance throughout flight.	

Table 4.5.1 Cruise Procedure

T1-POH-13	PAGE	Rev. Date
Revision: NC	4-9	11/14/2024

4.5 Before Landing

Before Landing	
1. Seats	ADJUSTED and LOCKED
2. Brakes	FIRM and EVEN
3. Safety Harnesses	SECURE
4. Fuel Selector Valve	RH or LH (Fullest Tank)
5. Lights	AS REQUIRED
6. Flaps	AS REQUIRED (0° – 30°)
7. Auxiliary Fuel Pump	ON
8. Airspeed	55 – 65 KIAS (Normal Approach) 50 – 55 KIAS (Short Field Approach) 50 KIAS (1.3 V _{SO})

Table 4.6.1 Before Landing Procedure

- **Short Field Landing:**

Procedure: With 30° of full flaps, focus on your aim point on the runway and maintain 50 – 55 KIAS throughout the approach. Pitch for airspeed and use throttle to maintain glidepath. Upon touchdown, use maximum braking without locking up the main wheels and retract flaps to transfer weight to the main wheels for maximum braking effectiveness/authority.

- **Soft Field Landing**

Procedure: With 30° of full flaps, touchdown with as minimal downward momentum possible (can cushion touchdown with slight engine power if desired). Keep the nose wheel off the ground as long as possible with appropriate elevator back pressure and flaps remaining 30° throughout rollout.

4.6 Balked Landing (Go Around)

Balked Landing (Go Around)	
1. Throttle	FULL
2. Airspeed	CLIMB (V _y or V _x)
3. Flaps	RETRACTED

Table 4.7.1 Balked Landing Procedure

- **4.6.1 Sideslip**

Sideslip to approach

Sideslip is recommended with a fuel selector valve selected for the highest wing during the maneuver.

4.7 After Landing

After Landing	
1. Flaps	RETRACTED
2. Auxiliary Fuel Pump	OFF
3. Trim Tab	NEUTRAL
4. Lights	AS REQUIRED
5. Transponder	AS REQUIRED
6. Radios	AS REQUIRED

Table 4.8.1 After Landing Procedure

4.8 Engine Shut Down

Engine Shut Down	
1. Throttle	IDLE
2. Lights	OFF
3. EFIS Switch (if installed)	OFF
4. Alternator Switch (if dual alternator)	OFF
5. Master Avionics Switch	OFF
6. Lane A & Lane B	OFF
7. Main and Auxiliary Fuel Pump	OFF
8. Batt Switch	OFF
9. Battery Master Switch	OFF
10. BCKP PWR Master Switch (if installed)	OFF
11. Fuel Selector Valve	OFF
12. Covers, Control Locks, Chocks	IN PLACE
13. Parachute Launching Handle	Locked

Table 4.9.1 Engine Shut Down Procedure

	Colt 100	SECTION 4
	PILOT'S OPERATING HANDBOOK	NORMAL PROCEDURES

CAUTION

Potential damage may occur to the aircraft if the control lock is not used especially if windy and gusty conditions arise. To prevent possible obstruction in the pitot and fuel system, use pitot and fuel vent covers whenever the aircraft is not in operation. Use chocks on at least two tires if possible. Tie-down the aircraft with ropes to ensure the aircraft remains secure and the use of a tail stand is recommended.

T1-POH-13	PAGE	Rev. Date
Revision: NC	4-12	11/14/2024



Intentionally left in blank

	Colt 100	SECTION 5
	PILOT'S OPERATING HANDBOOK	PERFORMANCE

5 PERFORMANCE

Table of Contents

5 PERFORMANCE	1
5.1 Total Takeoff Distance	2
5.2 Total Landing Distance	4
5.3 Rate of Climb	5
5.4 Cruise Speed, RPM, and Fuel Consumption	5
5.5 Stall Speeds	7
5.6 Glide	8

T1-POH-13	PAGE	Rev. Date
Revision: NC	5-1	11/14/2024

NOTE

Flight operations are APPROVED with wheel fairings either INSTALLED or UNINSTALLED. There is a slight reduction in TAS for flight operations with wheel fairings uninstalled.

5.1 Total Takeoff Distance

- Conditions:*
 Use of short field takeoff technique described in Section 4.4
 Maximum Weight – 1320 lbs / 600 kg
 Most Fwd CG
 Flaps – 10°
 Paved Runway
 Sea Level

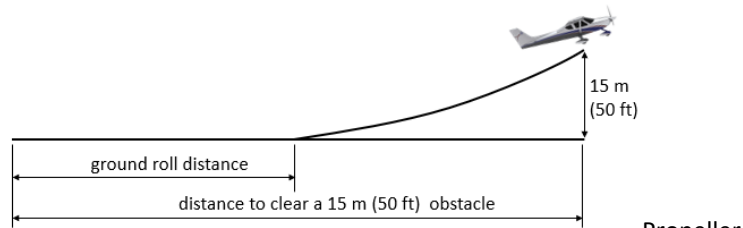

Figure 5.1.1 Takeoff Distance



Sterna Propeller										
Altitude (ft) / Pressure (in Hg)	0°C		10°C		20°C		30°C		40°C	
	Grd Roll (ft)	Dist. Over 50 ft Obs. (ft)	Grd Roll (ft)	Dist. Over 50 ft Obs. (ft)	Grd Roll (ft)	Dist. Over 50 ft Obs. (ft)	Grd Roll (ft)	Dist. Over 50 ft Obs. (ft)	Grd Roll (ft)	Dist. Over 50 ft Obs. (ft)
0 / 29.92	713	992	818	1127	934	1275	1061	1594	1200	1615
1000 / 28.85	819	1128	939	1282	1072	1451	1218	1820	1378	1844
2000 / 27.82	941	1284	1079	1461	1232	1656	1400	1606	1585	2110
3000 / 26.82	1083	1465	1241	1668	1417	1894	1134	2303	1826	2423
4000 / 25.84	1016	1402	1429	1910	1633	2172	1858	2756	2109	2794
5000 / 24.89	1437	1919	1649	2193	1886	2501	2149	3191	2443	3238
6000 / 23.98	1659	2206	1906	2528	2183	2892	2494	3716	2842	3777
7000 / 23.09	1920	2546	2210	2928	2537	3363	2905	4358	3321	4441
8000 / 22.22	2229	2953	2571	3410	2959	3938	3400	5157	3902	5280
9000 / 21.39	2597	3444	3004	4000	3470	4653	4004	6175	4618	6374
10000 / 20.58	3038	4046	3528	4736	4093	5564	4749	1833	5514	7878

5.2 Total Landing Distance

- Conditions:**
 Use of short field landing technique described in Section 4.6
 Maximum Weight – 1320 lbs / 600 kg
 Most Fwd CG
 Flaps – Full 30°
 Paved Runway
 Sea Level
 No wind

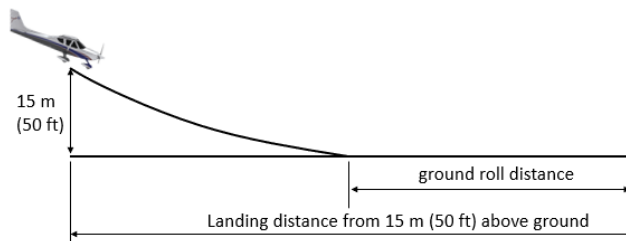

Figure 5.2.1 Landing Distance

Ground Roll Distance	285 ft (87 m)
Landing Distance with 50 ft (15 m) Obstacle	1044 ft (318 m)
Dry Grass - Landing Distance with 50 ft (15 m) Obstacle	1252 ft (382 m)
Wet Grass - Landing Distance with 50 ft (15 m) Obstacle	1670 ft (509 m)

Table 5.2.1 Total Landing Distance

5.3 Rate of Climb

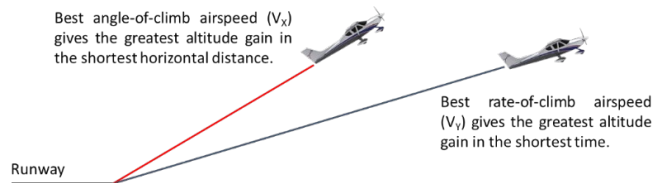

Figure 5.3.1 Rate of Climb

- **Conditions:**
 Maximum Weight - 1320 lbs / 600 kg
 Most Fwd CG
 Flaps (10°)
 No Wind

Pressure Altitude [ft]	Vx [knots]	R/C(ft/min)
		Sterna Propeller
0	59.1	626
2000	59.1	561
4000	59.1	496
6000	59.1	432
8000	59.2	367
10000	59.2	301
12000	59.4	237
14000	60.3	172

Table 5.3.1 Rate of Climb

A rate of Climb of **760 ft/min** at MTOW and V_Y of 64 knots can be reached with flaps retracted. At the same configuration V_X is 60 knots.

5.4 Cruise Speed, RPM, and Fuel Consumption

1. **Conditions:** MTOW = 1320 lbs / 600 kg, full fuel, ISA conditions
2. **Note:** Subtract 1.5% of KTAS for each increase in 10°C
3. **Wheel Fairings:** Subtract 3 KTAS for flights with wheel fairings uninstalled



Pressure Altitude [ft]	OAT [°C]	RPM	KTAS [knots]	Fuel Flow [US gal/h]	Endurance [h]*	Range [NM]*
2000	11	5500	120	7.2	3:48	464
		5200	116	5.9	4:43	546
		4800	103	4.8	5:58	614
		4350	91	3.4	8:41	794
4000	7	5450	119	6.8	4:01	480
		5200	115	5.8	4:50	553
		4800	105	4.6	6:14	656
		4350	92	3.2	9:04	831
6000	3	5450	121	6.6	4:10	503
		5200	115	5.5	5:07	589
		4800	103	4.6	6:14	643
		4350	89	3.3	8:57	792
8000	-1	5350	117	6.3	4:25	517
		5200	112	5.6	4:59	559
		4800	101	4.4	6:34	661
		4350	87	3.3	8:57	777
10000	-5	5300	114	6.0	4:39	529
		5200	111	5.7	4:57	550
		4800	100	4.3	6:37	658
		4350	88	3.1	9:27	834

*With a 30 minute fuel reserve.

Table 5.4.1 Cruise, Fuel, and Time

5.5 Stall Speeds

- Conditions:**
 Maximum Weight - 1320 lbs / 600 kg
 Most Fwd CG
 Throttle at Idle

Flap Settings	Angle of Bank				
	Level	15°	30°	45°	60°
	CIAS	CIAS	CIAS	CIAS	CIAS
Landing (30°)	38	39	41	45	54
Takeoff (10°)	40	41	43	48	57
Retracted (0°)	44	45	47	52	62

Table 5.5.1 Stall Speed

WARNING

ACCELERATED TURNING STALLS WITH A REDUCTION OF AIRSPEED MORE THAN 3-5 KTS PER SECOND MAY CAUSE SPINS.

NOTE

The stall speeds shown in the table above are in KIAS. Use the Airspeed Calibration Curve for CAS and the Conversion Table for MPH if desired.

5.6 Glide

- *Conditions:*
 Maximum Weight - 1320 lbs / 600 kg
 Most Fwd CG
 Flaps Retracted

Engine Power	KIAS	Glide Ratio	Distance traveled per 1000 ft of altitude loss
Idle	60	11.3 / 1	1.86 NM
	65	9.0 / 1	1.48 NM
Off	60	9.9 / 1	1.62 NM

Table 5.6.1 Glide Distance

The above performance tables are based on the airplane weight of 1320 lbs, standard atmospheric conditions, sea level, hard-surface runways, and no wind. They are calculated values derived from flight tests conducted by Texas Aircraft Manufacturing, INC under carefully documented conditions and will vary with individual airplanes and numerous factors affecting flight performance.



Intentionally left in blank

	Colt 100	SECTION 6
	PILOT'S OPERATING HANDBOOK	WEIGHT AND BALANCE

6 WEIGHT AND BALANCE

Table of Contents

6 WEIGHT AND BALANCE	1
6.1 Weight and Balance Charts	2
6.2 General References for Weight and Balance	3
6.3 Center of Gravity Calculations	3
6.3.1 Calculation of Aircraft CG for Flight Operations	3
6.3.2 Weight and Balance Quick Reference Tables	5
6.4 Equipment List	6
6.5 CG Calculation Form	6

T1-POH-13	PAGE	Rev. Date
Revision: NC	6-1	11/14/2024

6.1 Weight and Balance Charts

The following chart below is used in determining the CG of the aircraft. The charts outline the maximum weight limit (1320 lbs) as well as the most forward and aft CG limits. Prior to flight, the aircraft must be inside the CG envelope.

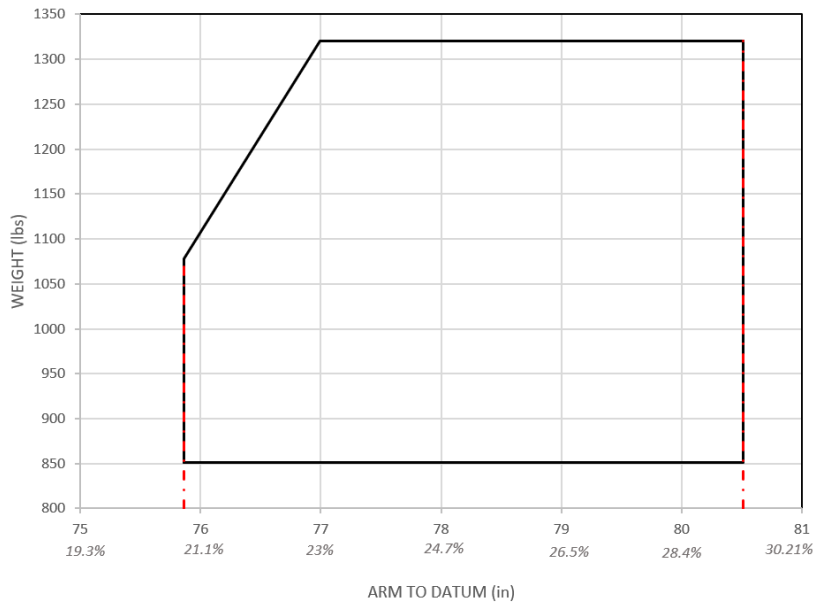

Figure 6.1.1 CG envelope for Colt 100

6.2 General References for Weight and Balance

See the following table for general references regarding weights and allowable CG ranges for flight.

MTOW	1320 lbs / 600 kg
Basic Empty Weight (including unusable fuel)	851.0 lbs / 386.0 kg*
Maximum Baggage Weight	44 lbs / 20 kg
Maximum Fuel	31.7 US gal / 120 l
Most Forward CG	75.86 in (20.85%)
Most Aft CG	80.51 in (29.32%)

*Weight can change from one aircraft to another. See specific basic empty weight for your airplane.

Table 6.2.1 General References for Weight and Balance

WARNING

THE PILOT IS RESPONSIBLE TO CORRECTLY LOAD THE AIRCRAFT. THE CONFIGURATION BEYOND THE CG BOUNDARIES COULD RESULT IN UNSTABLE FLIGHT, ACCIDENT AND/OR LOSS OF LIFE.

6.3 Center of Gravity Calculations

6.3.1 Calculation of Aircraft CG for Flight Operations

Pilot and Passenger	82.99 in / 2.108 m
Fuel	86.50 in / 2.197 m
Baggage	107.99 in / 2.743 m

	Colt 100	SECTION 6
	PILOT'S OPERATING HANDBOOK	WEIGHT AND BALANCE

Leading Edge [LE]	64.35 in / 1.634 m
Wing Chord [c]	55.12 in / 1.400 m

Table 6.3.1 Reference table for flight operations and CG calculations

Use the following formulas to calculate the center of gravity:

$$\%CG = \frac{(CG-LE)}{c} * 100 \quad CG (in) = \frac{total\ moment\ (in)}{total\ weight\ (in)} \quad Weight * Arm = Moment$$

● **Example of CG Calculation**

Below, is an example of the CG calculation for flight expressed in inches and percentage.

Item	Weight [lb]	Arm [in]	Moment
Empty Aircraft	851.0*	75.45*	64208
Fuel	120.0	86.50	10380
Pilot	180.0	82.99	14938
Passenger	150.0	82.99	12448
Parachute Rescue System	29.8	129.15	3849
Baggage	10.0	107.99	1080
Totals	1311.0	SEE BELOW	103056
CG (in) = $\frac{total\ moment\ (in)}{total\ weight\ (in)}$		CG Inches <u>78.61</u>	
%CG = $\frac{(CG-LE)}{c} * 100$		CG % <u>25.87%</u>	

*These values may change, see the Weight and Balance Form to obtain the correct weight and balance report.

Table 6.3.2 Example of CG Calculation

The CG is within the CG range of 75.86 inches (20.85%) and 80.51 inches (29.32%). A Weight and Balance Loading Form for flight can be found in Section 9 Supplements.

T1-POH-13	PAGE	Rev. Date
Revision: NC	6-4	11/14/2024

6.3.2 Weight and Balance Quick Reference Tables

Reference the following tables to calculate weight and CG limits. Pilot & Passenger

Weight (lbs.)	Moment (in.)	Weight (lbs.)	Moment (in.)
100	8299.0	220	18257.8
110	9128.9	230	19087.7
120	9958.8	240	19917.6
130	10788.7	250	20747.5
140	11618.6	260	21577.4
150	12448.5	270	22407.3
160	13278.4	280	23237.2
170	14108.3	290	24067.1
180	14938.2	300	24897.0
190	15768.1	310	25726.9
200	16598.0	320	26556.8
210	17427.9		

Table 6.3.2.1 Weight Moment

Fuel		
Gallons	Weight (lbs.)	Moment (in.)
3	18	1557
6	36	3114
9	54	4671

12	72	6228
15	90	7785
18	108	9342
21	126	10899
24	144	12456
27	162	14013

30	180	15570
----	-----	-------

Table 6.3.2.2 Fuel Moment

Baggage	
Weight (lbs.)	Moment (in.)
5	539.95
10	1079.90

15	1619.85
20	2159.80
25	2699.75
30	3239.70
35	3779.65
40	4319.60

Table 6.3.2.3 Baggage Moment

6.4 Equipment List

THE EQUIPMENT LIST IS A SEPARATE DOCUMENT FURNISHED WITH THE AIRCRAFT BY THE MANUFACTURER WHICH SPECIFIES ALL EQUIPMENT INSTALLED WHEN THE AIRCRAFT LEFT THE FACTORY. THE EQUIPMENT LIST IS SPECIFIC AND UNIQUE TO EACH TEXAS AIRCRAFT COLT 100 AIRCRAFT.

o

6.5 CG Calculation Form

This form must be completed with your airplane's information. The Weight and Balance form is delivered with the airplane documentation.

 508 Vandenberg Rd, Hondo, TX

CG CALCULATION FORM

Revision A

Manufactured by: Texas Aircraft Manufacturing INC	Date:	
Aircraft Model: COLT 100	Serial Number:	Registration Number:

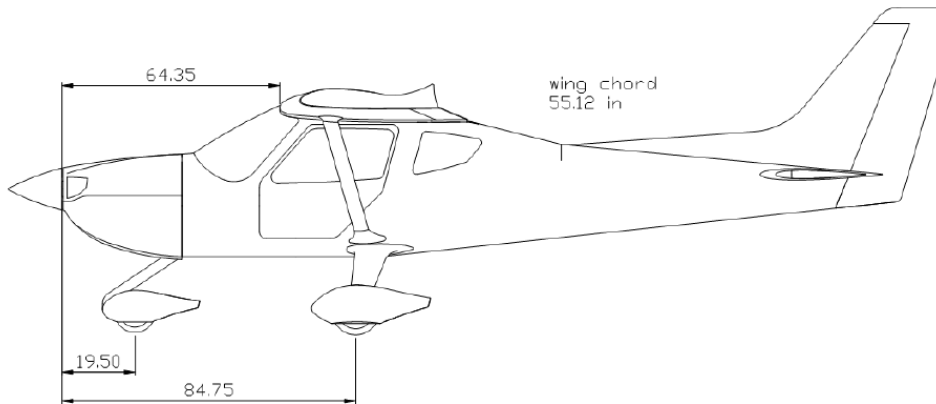

Item	Weight [lb]	Arm [in]	Moment [lb x in]
Empty Aircraft			
Passenger		82.99	
Pilot		82.99	
Fuel		86.50	
Baggage		107.99	
Σ (Totals)		N/A	
CG(in) = ΣMoments/ΣWeight	N/A		N/A
CG(%) = [(CG(in) - 64.35) / 55.12] * 100	N/A		N/A

The CG range is 75.86 inch (20.85%) and 80.51 inch (29.32%).



CG CALCULATION FORM

Revision A

508 Vandenberg Rd, Hondo, TX

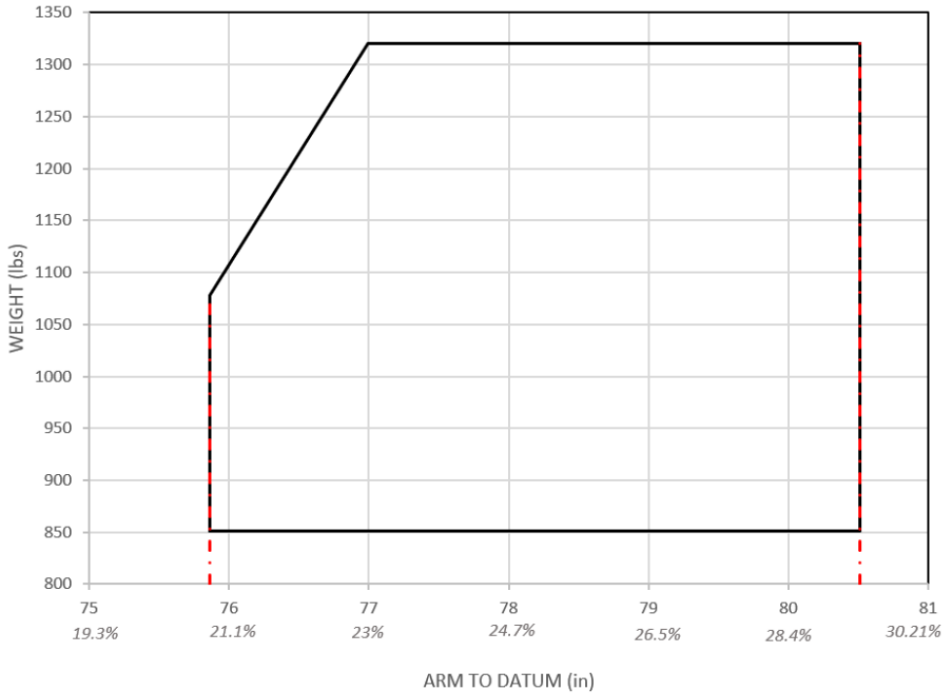

T1-POH-13	PAGE	Rev. Date
Revision: NC	6-9	11/14/2024



Intentionally left in blank

	Colt 100	SECTION 7
	PILOT'S OPERATING HANDBOOK	AIRPLANE DESCRIPTION

7 AIRPLANE DESCRIPTION AND SYSTEMS

Table of Contents

7 AIRPLANE DESCRIPTION AND SYSTEMS

7 AIRPLANE DESCRIPTION AND SYSTEMS	1
7.1 General Information	1
7.2 Airframe	4
7.3 Flight Controls	4
7.3.1 Panel	7
o Dynon System	7
7.3.2 Dynon Flight Instruments	8
7.3.3 Avionics Software Update - Dynon	2
7.4 Electrical System	2
7.4.1 Standard Configuration for Single Screen System	2
7.5 Pitot Static System	6
7.6 Fuel System	6
7.7 Lubrication System	7
7.8 Coolant System	8
7.9 Engine	8
7.9.1 Engine Specifications	10
7.9.2 Engine Performance	11
7.10 Propeller	11
7.11 Landing Gear	12

7.1 General Information

The Colt 100 a two-seat side-by-side airplane configuration.

Wing Span	32.22 ft / 9.820 m
Mean Aerodynamic Chord	4.59 ft / 1.4 m
Length	22.83 ft / 6.96 m
Height	7.84 ft / 2.39 m
Wing Area	138.75 ft ² / 12.89 m ²
MTOW	1320 lbs / 600 kg
Maximum Baggage Weight	44 lbs / 20 kg
Wing Loading	9.5 lbs/ft ² / 46.6 kg/m ²
Maximum Interior Cabin Width	42.9 in / 1.09 m

T1-POH-13	PAGE	Rev. Date
Revision: NC	7-1	11/14/2024

Maximum Interior Cabin Height	35.4 in / 0.9 m
G Load	+4 / -2
G Load with Flaps extended	+2 / -0

Table 7.1.1 General Information

All structural parts have been tested according to ASTM F2245-16C, which requires a mandatory ultimate load factor of 1.5. This implies a tested G load factor of +6 / -3.

WARNING

DO NOT EXCEED THE MAXIMUM TAKEOFF WEIGHT SPECIFIED IN THIS MANUAL. ANY NON-TESTED CONFIGURATION MAY CAUSE UNCONTROLLABLE FLIGHT. FAA (14 CFR §1.1) ALLOWS A MAXIMUM TAKEOFF WEIGHT OF 1320 LBS FOR S-LSA AIRCRAFT.

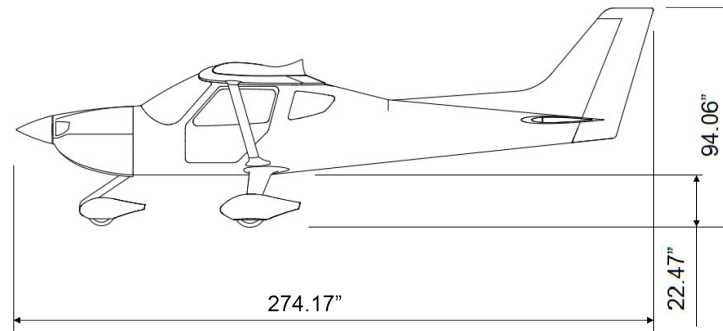

Figure 7.1.1 Side View Drawing

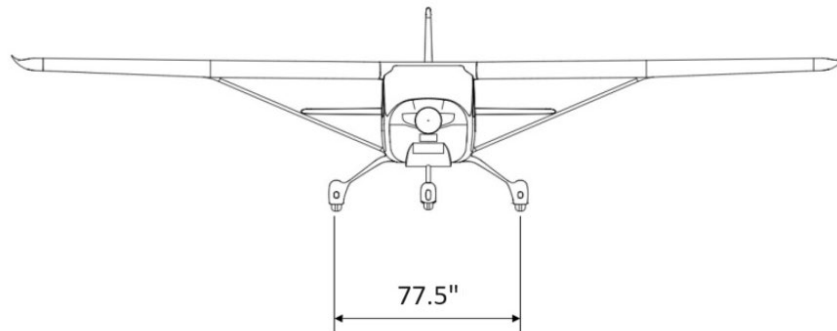

Figure 7.1.2 Front View Drawing

T1-POH-13	PAGE	Rev. Date
Revision: NC	7-2	11/14/2024

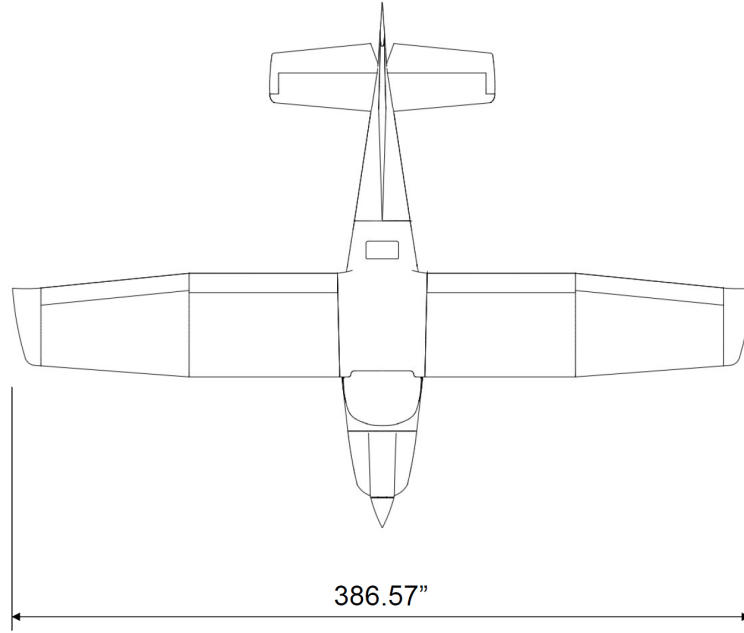

Figure 7.1.3 Top View Drawing

T1-POH-13	PAGE	Rev. Date
Revision: NC	7-3	11/14/2024

7.2 Airframe

The airframe is composed of a fuselage, empennage, wings, control surfaces, and a fixed tricycle landing gear.

The fuselage is a combination of truss and semi-monocoque construction and is riveted together using aviation grade aluminum 2024-T3 sheets around a tubular 4130 Chromoly steel safety cell. The safety cell is TIG welded. The tail cone is fabricated by banded stringers and frames riveted together with 2024-T3 aluminum sheets.

The wings, empennage, and control surfaces are fabricated by bending, stamping, and rolling. They are riveted together with 2024-T3 aluminum sheets.

The nose landing gear is fabricated with 4130 Chromoly steel tubes while the main landing gear is fabricated from a solid plate of 7075-T6 aluminum. The nose wheel is 11x4.00-5 and main wheels are 5.00-5.

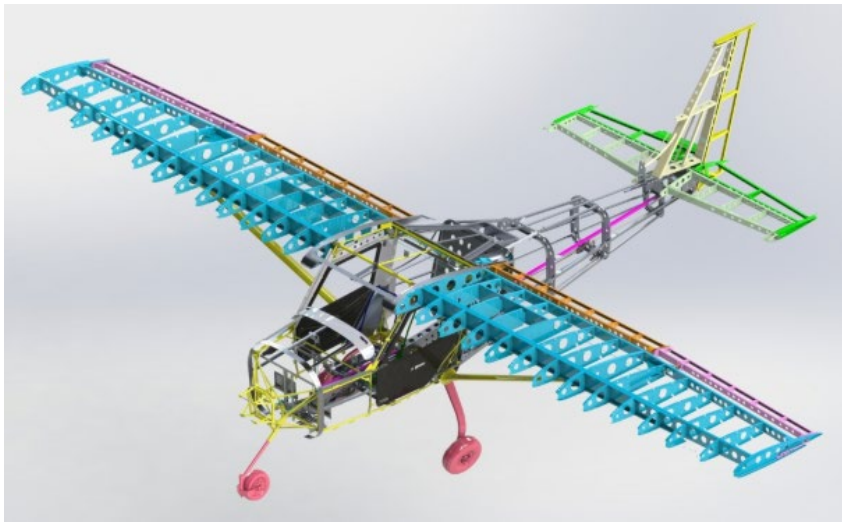

Figure 7.2.1 Colt 100 Airframe

7.3 Flight Controls

The flight controls consist of ailerons, flaps, rudder, elevator, and elevator trim tab. See figure 7.3.1 below to reference the flight controls. The next table shows the total areas and nominal deflections of specific flight controls.

T1-POH-13	PAGE	Rev. Date
Revision: NC	7-4	11/14/2024

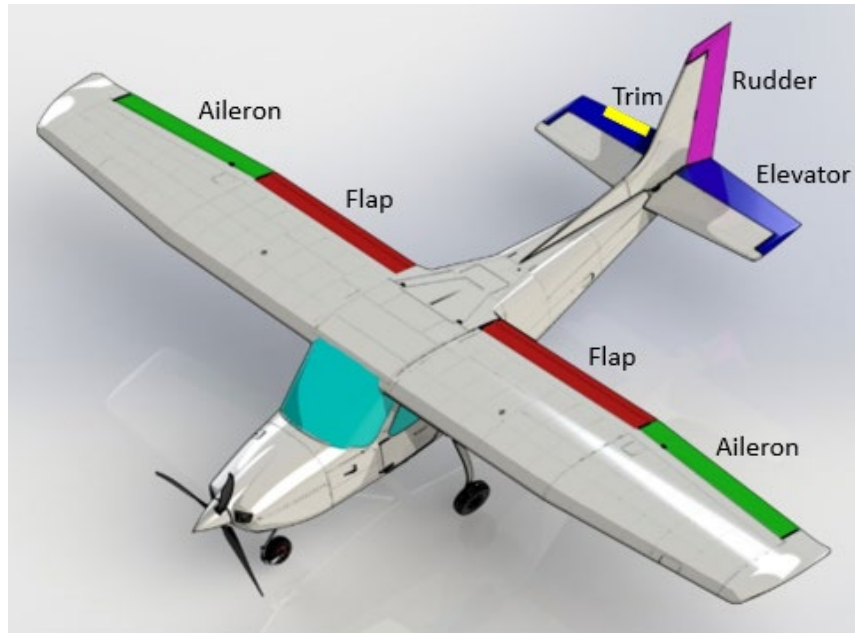

Figure 7.3.1 Colt 100 Flight Controls

T1-POH-13	PAGE	Rev. Date
Revision: NC	7-5	11/14/2024

	Colt 100		SECTION 7
	PILOT'S OPERATING HANDBOOK		AIRPLANE DESCRIPTION

Areas and Deflections

Ailerons	Area		5.60 ft ² / 0.520 m ²
	Deflection		+20° ± 4°
			-15° ± 4°
Flaps	Area		6.78 ft ² / 0.63 m ²
	Deflection	Takeoff	10°
		Landing	30° ± 3°
Elevator	Area		10.76 ft ² / 1.00 m ²
	Deflection		+25° ± 5°
			-25° ± 5°
Rudder	Area		6.46 ft ² / .6 m ²
	Deflection		+20° ± 4°
			-20° ± 4°
Elevator Trim Tab	Area		72.85 in ² / 0.047 m ²
	Deflection		+20° ± 2°
			-18° ± 2°

Table 7.3.1 Flight Control Areas and Deflections

T1-POH-13	PAGE	Rev. Date
Revision: NC	7-6	11/14/2024

Instruments – Dynon System

7.3.1 Panel

- Dynon System

The follow equipment and instruments are mounted on the standard cockpit panel:



Figure 8.2.1 Instrument Panel for Dynon System

1- Ignition Switch	9 - Autopilot Disconnect Button
2- One circuit Breaker 25A	10- Comm 1 or 2 Transmit Switch
3- Flap Control Switch	11- Choke Control Knob
4- 12V Receptable	12- EFIS Data USB
5 - USB Charger	13- Airspeed Indicator
6- Dimmer Control	14- Altimeter
7-ELT Remote Switch	15- Vertical Speed Indicator
8- Air Vents	16- Inclinator

	Colt 100	SECTION 7
	PILOT'S OPERATING HANDBOOK	AIRPLANE DESCRIPTION

Avionics:

17- Dynon Skyview HDX 10"	22- SV-INTERCOM-2S Two Place
18- SV-AP-PANEL SkyView Autopilot	23- Pilot Headset (Mic/Phone/6 pin)
19- SV-KNOB-PANEL Autopilot	24- Co-pilot Headset (Mic/Phone/ 6pin)
20- SV-COM-C25 SkyView VHF Com Radio 1	25- Skymaster
21- SV-COM-C25 SkyView VHF Com Radio 2	

*The circuit breakers and switches may change according to the avionics, instruments and modules installed in the Colt 100 .

*The circuit breakers and switches are subject to change according to the avionics, instruments and modules installed in the Colt 100.

7.3.2 Dynon Flight Instruments

The basic layout includes one 10 Dynon **SkyView** display, two Dynon SV-COM-C25 radios with a Dynon audio panel, and an analog suite of Backup instruments.

NOTE

For instruments and avionics operating instructions refer to the documentation supplied with the instruments and avionics. For additional support and manual operation search <https://support.garmin.com>.

T1-POH-13	PAGE	Rev. Date
Revision: NC	7-8	11/14/2024

	Colt 100	SECTION 7
	PILOT'S OPERATING HANDBOOK	AIRPLANE DESCRIPTION

7.3.3 Avionics Software Update - Dynon

The Software can be updated visiting this Dynon link, <https://www.dynonavionics.com/skyview-hdx-software-updates.php>, and follow the instructions below:

1. Download new files to your PC.
2. Transfer the files to a USB stick. Files must be in the "root" of the USB stick. In other words, they cannot be in a folder or directory.
3. Power up your SkyView.
4. Insert the USB stick into a SkyView USB port.
5. Use the SkyView Setup Menu to load the New files.
6. Reboot SkyView.

More details can be found on the Dynon homepage.

7.4 Electrical System

7.4.1 Standard Configuration for Single Screen System

The main power is supplied by a 250W AC generator with an external rectifier/regulator of 14.2VDC, rated to 22A at 5800 RPM, which recharges the battery in normal operation. A secondary source is supplied by the battery, with a capacity of 16Ah, which supplies system power when the engine is turned off or in case of alternator failure. The total electrical load during flight is rated to 17.1A. Electrical supply by the battery only will supply power for a minimum of 45 minutes assuming the battery capacity is 80%. The master relay connects the electrical supply into the circuit, feeding the Master bus and allowing engine start-up. One circuit breaker of 25A is installed to protect the electrical system.

T1-POH-13	PAGE	Rev. Date
Revision: NC	7-2	11/14/2024

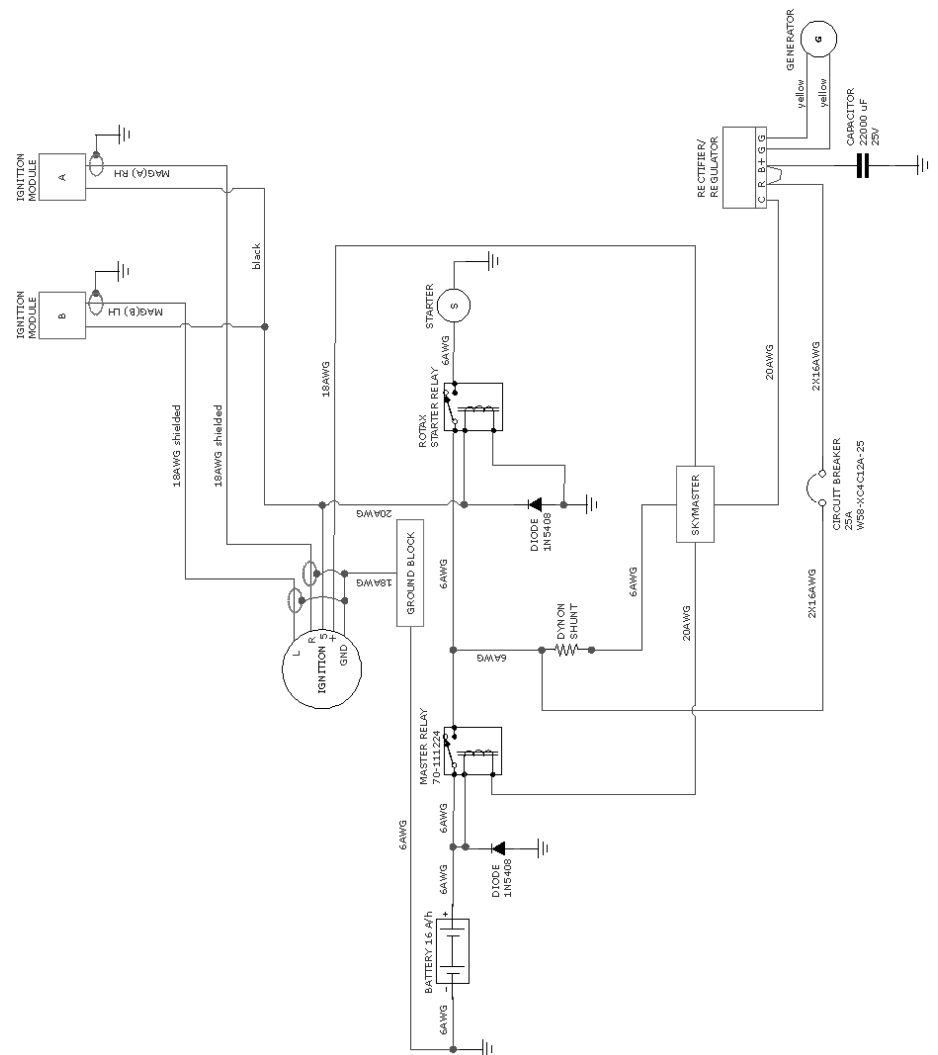

Figure 7.6.1.1 Electrical System Diagram

T1-POH-13	PAGE	Rev. Date
Revision: NC	7-3	11/14/2024

Full Configuration for Dynon

The main power is supplied by a 600 W/DC maximum output at 6,000 rpm externally mounted alternator, which recharges the battery in normal operation. There is also a secondary/backup 250W AC alternator with an external rectifier/regulator of 14.2 V/DC rated to 22A at 5800 RPM. A tertiary power source is supplied by a backup battery, with a capacity of 16Ah, which supplies system power when the engine is turned off or in case of alternator failure. The total electrical load during flight is rated to 26.46 Amps. Electrical supply by the battery only will supply power for a minimum of 45 minutes assuming the battery capacity is 80%. The master relay connects the electrical supply into the circuit, feeding the Master bus and Master Avionics, which feed the avionics bus, and allowing engine start-up. Two circuit breakers of 50A and 25A are installed to protect the electrical system.

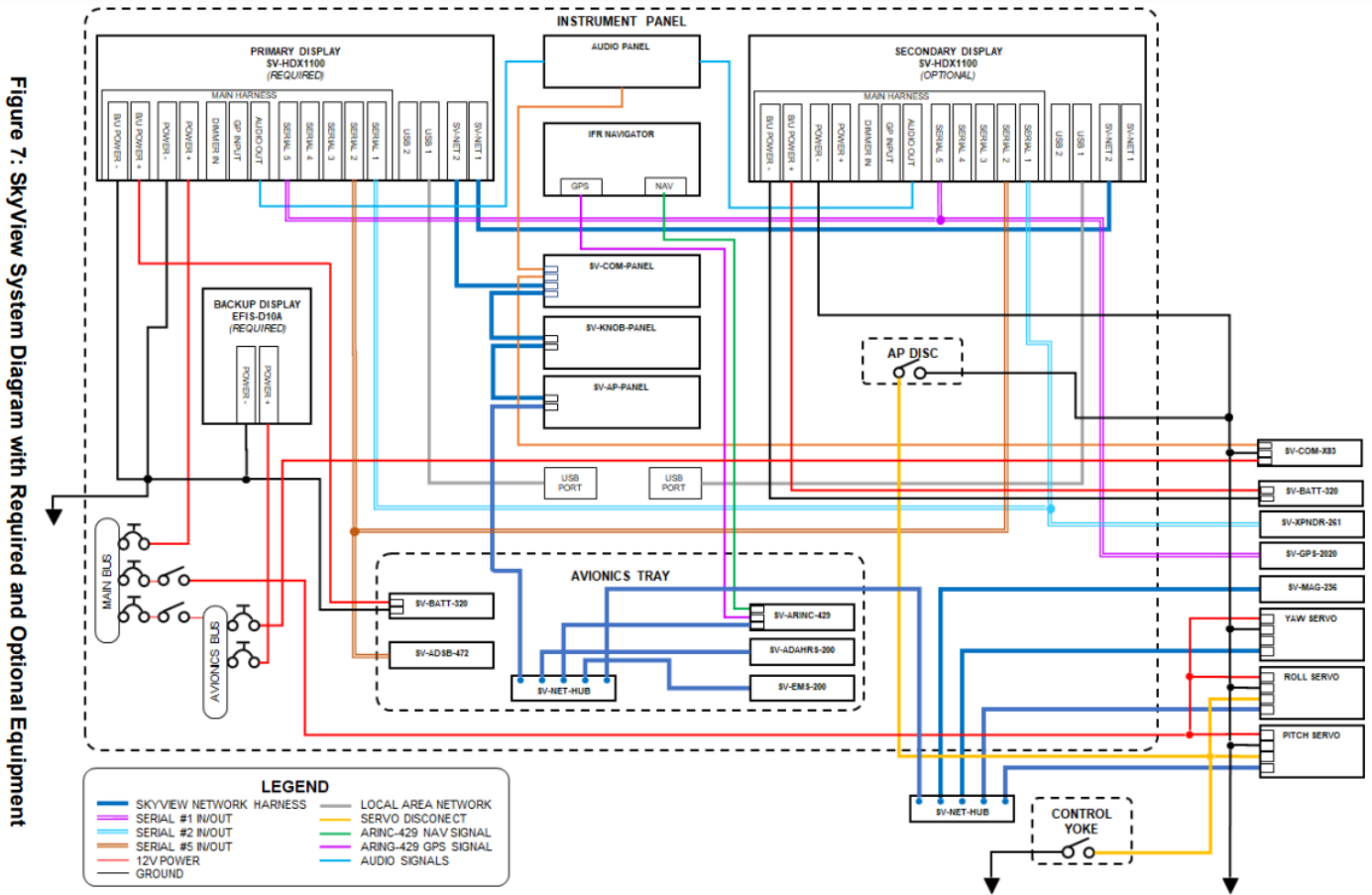

Figure 7.6.2.1 Power Distribution System Diagram

T1-POH-13	PAGE	Rev. Date
Revision: NC	7-4	11/14/2024

Figure 8: Engine Monitoring System Diagram with Optional Sensors

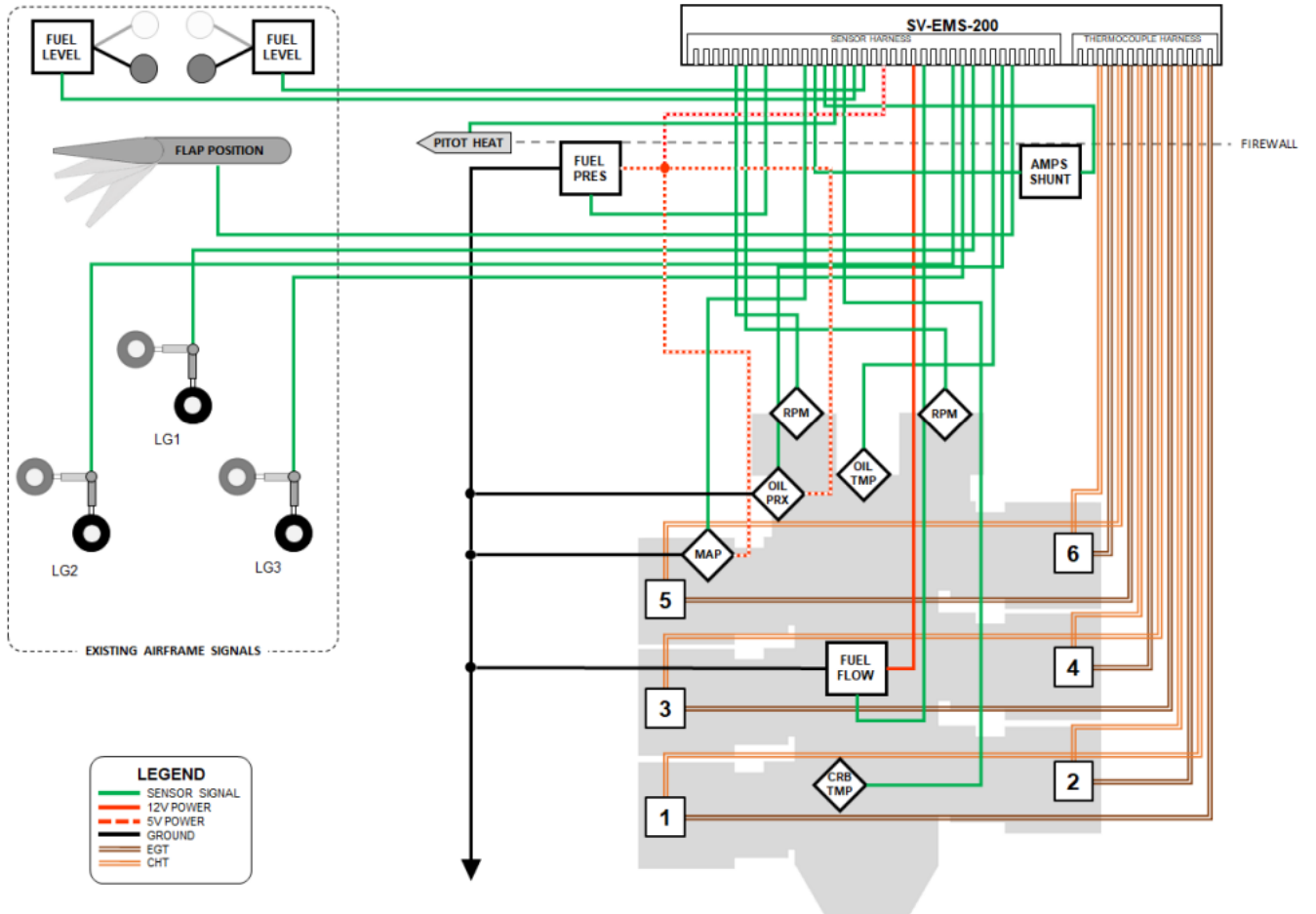

Figure 7.6.2.2 Optionals Power Distribution System Diagram

T1-POH-13	PAGE	Rev. Date
Revision: NC	7-5	11/14/2024

	Colt 100	SECTION 7
	PILOT'S OPERATING HANDBOOK	AIRPLANE DESCRIPTION

7.5 Pitot Static System

The pitot static system probe is installed in the left wing of the aircraft. This probe performs two functions which are airspeed sensing and angle of attack (AOA) sensing. These functions require having two pressure ports on the tip of the probe. The normal pitot pressure port is on the front face of the probe and is designed to be insensitive to angle of attack. The second pressure port is located on an angled surface just under the pitot port and is designed to be very sensitive to AOA. Pitot probes can be with or without heat.



Figure 7.7.1 Pitot Tube Probe

The Pitot Static System requires two pressures in order to measure the airspeed. They are the total pressure, which is measured from the pitot tube and the static pressure. The static pressure is obtained from two static pressure ports located on the left and right sides of the tail cone.

All the static system pressure lines are connected to the EFIS which is mounted on the instrument panel. Then, the angle of attack and airspeed are calculated automatically and displayed to the pilot digitally on the EFIS display.

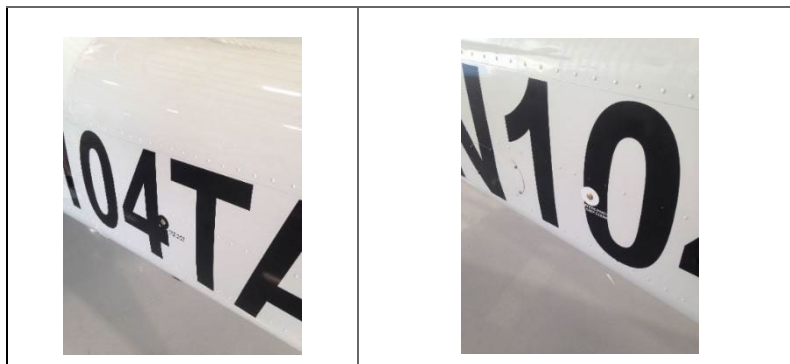

Figure 7.7.2 Static Pressure Ports on Tail Cone

7.6 Fuel System

The fuel system consists of one integral fuel tank in each wing totaling two tanks with a maximum total capacity of 31.7 US Gal. Both tanks are vented and serviced from the top of the wing through a fuel filler that also utilizes a locking fuel cap.

Each wing tank has two fuel feed lines with small orifices to reduce the risk of FOD (foreign object debris) or contamination in the fuel supply, and a drain at the lowest point.

A 3-position fuel selector with RH, LH, and OFF positions is installed in the system before the firewall. Inside the cowling, a gascolator is installed followed by the fuel pumps. The fuel line system is followed by the Rotax fuel pumps, return line and a fuel flow transducer are installed before the fuel inlet.

The inspection, cleaning, and/or servicing of the gascolator is made easy by removing the engine cowling. Per Rotax requirement, a return line is installed in the system, which is connected directly to the gascolator.

Refer to figure 7.8.1 below for the COLT fuel system diagram.

A return line is installed to each fuel tank.

T1-POH-13	PAGE	Rev. Date
Revision: NC	7-6	11/14/2024

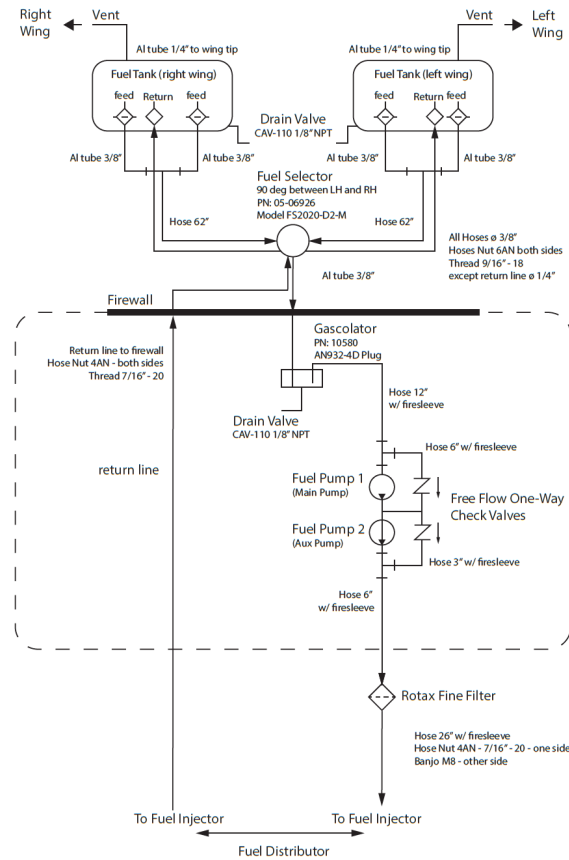
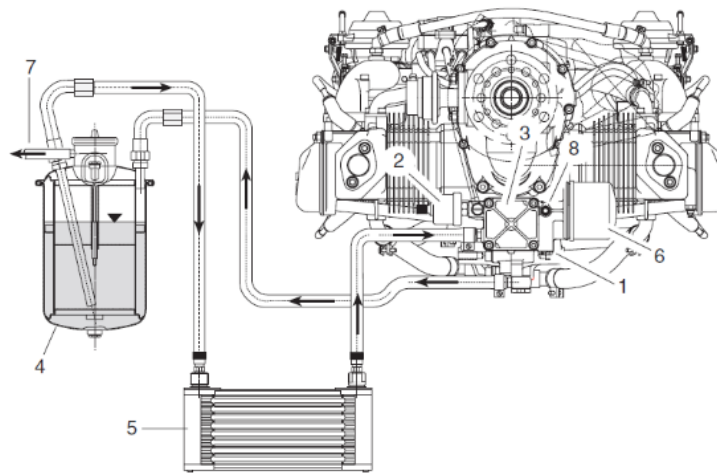

Figure 7.8.1 Fuel System Diagram

7.7 Lubrication System

The engine is equipped with a dry sump forced lubrication system consisting of a main oil pump, integrated pressure regulator, and oil pressure sensor. The oil pump draws oil from the reservoir. It then travels to the cooler then, through the oil filter and into various lubrication points of the engine. The surplus oil accumulates on the bottom of the crankcase and is forced back to the oil tank by blow-by gases. The oil circuit is vented through a vent line on the oil tank. The oil temperature sensor is located on the oil pump housing.



T1-POH-13	PAGE	Rev. Date
Revision: NC	7-7	11/14/2024

Figure 7.9.1 Lubrication System

7.8 Coolant System

The cooling system consists of liquid cooling of the cylinder heads and ram air cooling of the cylinders. The cooling system of the cylinder heads is a closed loop circuit with an expansion tank. The water pump driven by the camshaft provides system pressure. Coolant flows from the radiator to the cylinder heads and from there it flows to the expansion tank. After the expansion tank, the coolant flows back to the radiator to complete the loop circuit. The expansion tank is closed by a pressure cap. As coolant temperature rises, a pressure valve will open and coolant will flow to the transparent overflow bottle mounted on the firewall. When cooling down, the coolant will be drawn back into the cooling circuit.

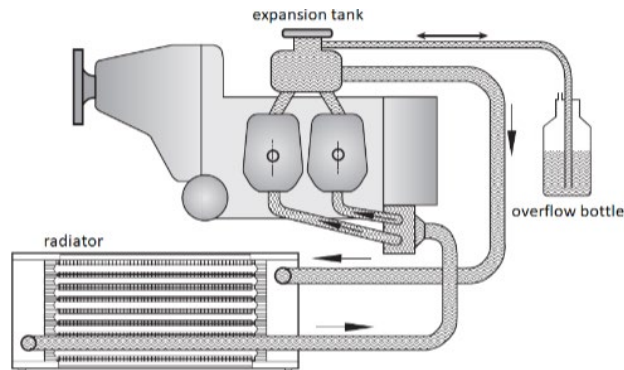

Figure 7.10.1 Coolant System

7.9 Engine

Manufacturer		BRP-Rotax GmbH & CO KG
Model		912 ULS2-01
Maximum Power	Take-off (5800 RPM)	100 hp / 73.5 kW (max 5 minutes)
	Max continuous (5500 RPM)	93 hp / 69.0 kW
Reduction Ratio (crankshaft: propeller shaft)		2.43

Table 7.11.1 Engine Information

T1-POH-13	PAGE	Rev. Date
Revision: NC	7-8	11/14/2024

	Colt 100	SECTION 7
	PILOT'S OPERATING HANDBOOK	AIRPLANE DESCRIPTION

7.9.1 Engine Specifications

Maximum Power	Takeoff (max 5 min)	100 hp / 73.5 kW
	Continuous	93 hp / 69.0 kW
Maximum Engine RPM	Takeoff (max 5 min)	5800 RPM
	Continuous	5500 RPM
Maximum Propeller RPM	Takeoff	2387 RPM
	Continuous	2264 RPM
Cylinder Head Temperature	Maximum	275°F / 135°C
Oil Temperature	Minimum	120°F / 50°C
	Normal	140°F - 230°F 60°C - 110°C
	Maximum	266°F / 130°C
Oil Pressure	Minimum	12 psi Below 3500 RPM
	Normal	29 - 72 psi Above 3500 RPM
	Maximum	102 psi
Fuel Pressure	Minimum	36 psi
	Maximum	51 psi
Engine Start OAT Limitations OAT limits For Engine Operation	Minimum	-13°F / -25°C
	Maximum	120°F / 50°C
Exhaust Gas Temperature (EGT)	Normal	1436°F / 780°C
	Maximum	1472°F / 800°C
	Maximum Takeoff	1616°F / 880°C

Table 7.11.1.1 Engine Specifications

T1-POH-13	PAGE	Rev. Date
Revision: NC	7-9	11/14/2024

CAUTION

The maximum oil pressure of 102 psi is admissible for a short period on a cold start.

7.9.2 Engine Performance

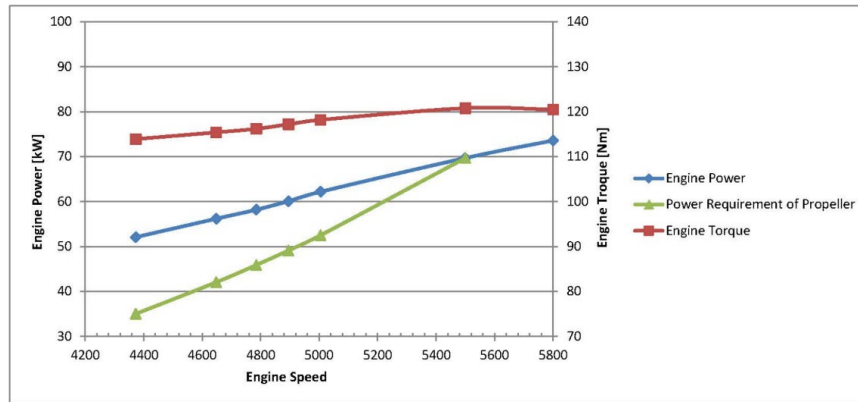

Figure 7.11.2.1 Engine Performance

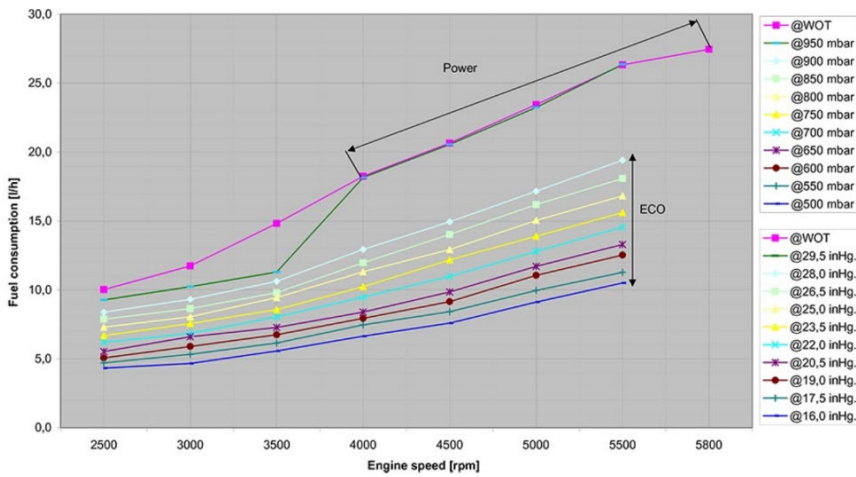

Figure 7.11.2.2 Fuel Consumption

7.10 Propeller

T1-POH-13	PAGE	Rev. Date
Revision: NC	7-10	11/14/2024

	Colt 100	SECTION 7
	PILOT'S OPERATING HANDBOOK	AIRPLANE DESCRIPTION

Sterna Propeler

Manufacturer	Sterna Propeller
Model Blade	S69CBMR-3LE-WR-C
Model Hub	3-RT-B
Number of Blades	3
Weight	9.7 lb / 4.40 kg
Diameter	69 in
Type	Fixed pitch
Pitch Adjust	18°
Propeller Ground Clearance	5.75 in / 146 mm

Table 7.12.1 Propeller Information

7.11 Landing Gear

Leg Structure	Main	Manufactured in Aluminum 7075-T6 by CNC Milling Machine
	Nose	Chromium-Molybdenum Steel tube
Wheel Assembly	Main	Beringer, RF-018(A)
	Nose	Beringer, RA-015(A)
Tire	Main	5.00-5 8Ply Michelin Air TL (recommended)
		5.00-5 6Ply Goodyear Custom III
	Nose	11x4.00-5 8Ply Aero Classic TL
Brake Assembly		Beringer, EA-002.2N(A)
Master Cylinders		Beringer, MP-002.5N(A)

Table 7.13.1 Landing Gear Information

T1-POH-13	PAGE	Rev. Date
Revision: NC	7-11	11/14/2024



Intentionally left in blank

	Colt 100	SECTION 8
	PILOT'S OPERATING HANDBOOK	HANDLING & SERVICING

8 HANDLING AND SERVICING

Table of Contents

8 HANDLING AND SERVICING

	1
8.1 Ground Handling	2
8.2 Aircraft Cleaning	3
8.3 Servicing of Fluids	4
8.3.3 Approved Coolant Grades and Specifications	5

T1-POH-13	PAGE	Rev. Date
Revision: NC	8-1	11/14/2024

	Colt 100	SECTION 8
	PILOT'S OPERATING HANDBOOK	HANDLING & SERVICING

8.1 Ground Handling

- **Towing**

If a tow bar is available, attach it to the tow bar, attach points on the nose gear fork for steering and moving the airplane on the ground. If not, the aircraft should be moved by pulling on the propeller near the hub or pushing on the wing struts applying differential pressure on the struts for turning. You can also press the tail cone down in front of the empennages to raise the nose wheel and turn the aircraft. Be sure to apply pressure on reinforced (riveted) structure. Also, be careful to not touch the tail on the ground and never use the control surfaces to move the aircraft.

- **Tie-Down**

Position the aircraft into the wind if possible, prior to tie-down. There are three tie-down points. One on each wing strut and one on the tail cone. Use of a tail-stand is recommended in adverse weather to prevent the tail from dropping to the ramp in gusty conditions. Even with all three tie-down points secure with a rope the tail can drop (see figure 8.1.1 below).



Figure 8.1.1 Aircraft Securing

- **Jacking**

Recommended use of a 9" 2x6 wooden jack pad placed under the left or right jack point placard on the belly of the aircraft. There are two structural rivet lines the jack pad fits between when under the jack point. Any style jack can be used to support the jack pad (see figure 8.1.2 below).

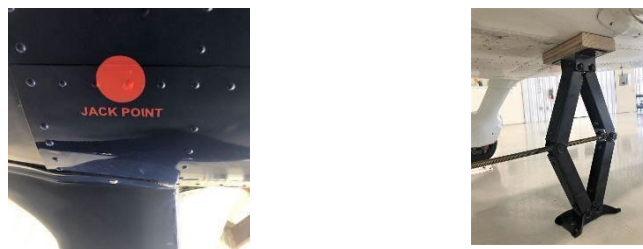



Figure 8.1.2 Aircraft Jacking

T1-POH-13	PAGE	Rev. Date
Revision: NC	8-2	11/14/2024

	Colt 100	SECTION 8
	PILOT'S OPERATING HANDBOOK	HANDLING & SERVICING

8.2 Aircraft Cleaning

CAUTION

Use only approved aviation-grade aircraft cleaning products that are designed for aircraft exterior cleaning to prevent corrosion of aircraft aluminum structure and components.

CAUTION

Use only water, Plexus®, or Clear View™ along with a shammy or microfiber for cleaning of the aircraft windscreen. Always wipe in the direction of airflow over the windscreen. Any other cleaning solution is not approved.

T1-POH-13	PAGE	Rev. Date
Revision: NC	8-3	11/14/2024

	Colt 100	SECTION 8
	PILOT'S OPERATING HANDBOOK	HANDLING & SERVICING

8.3 Servicing of Fluids

8.3.1 Approved Fuel Grades and Specifications

Fuel	AVGAS 100 LL (Recommended) or MOGAS Premium (91 octane - EN 228 Super Standard, up to 5% ethanol max)
Usable Fuel	30.9 US gal (117 l)
Total Fuel	31.7 US gal (120 l)

Table 8.3.1.1 Approved Fuel Grades and Specifications

8.3.2 Approved Oil Grades and Specifications

Oil*	AeroShell Sport Plus 4 (recommended)
Oil Capacity	Min 2.6 US quart (2.5 l)
	Max 3.2 US quart (3.0 l)

*Preferred oil grade depends on the operating climatic condition and can be found in the Rotax 912-Series Operator Manual.

Table 8.3.2.1 Approved Oil Grades and Specifications

T1-POH-13	PAGE	Rev. Date
Revision: NC	8-4	11/14/2024

The temperature range for various grade oils (see figure 8.3.2.1 below.) More information can be found in the Rotax Operators Manual.

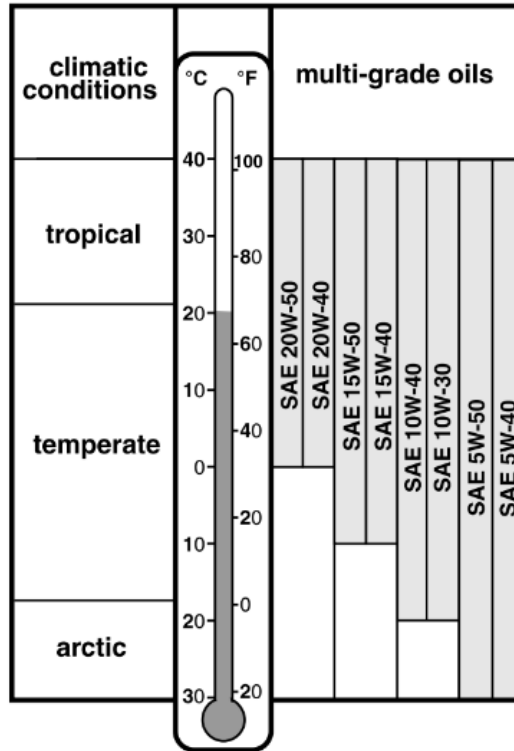

Figure 8.3.2.1 Oil Viscosity

NOTE

Multi-viscosity grade oils are less sensitive to temperature variations than single grade oils. They are suitable for use throughout the year, ensure rapid lubrication of all engine components on cold starts, and retains viscosity better at higher temperature.

8.3.3 Approved Coolant Grades and Specifications

Cooling System	Liquid / Ram-Air
Coolant*	Prestone 50/50 Prediluted Antifreeze/Coolant (recommended) See Rotax Operators Manual

*Do not add water or mix different coolants.

T1-POH-13	PAGE	Rev. Date
Revision: NC	8-5	11/14/2024

	Colt 100	SECTION 8
	PILOT'S OPERATING HANDBOOK	HANDLING & SERVICING

* See Rotax 912-Series Operator Manual

Table 8.3.3.1 Approved Coolant Grades and Specifications

CAUTION

Verify coolant level in the overflow bottle mounted on the firewall, fill as required to be between the max and min mark indicated on the plastic bottle.

T1-POH-13	PAGE	Rev. Date
Revision: NC	8-6	11/14/2024



Intentionally left in blank

	Colt 100	SECTION 9
	PILOT'S OPERATING HANDBOOK	SUPPLEMENTS

9 SUPPLEMENTS

Table of Contents

9 SUPPLEMENTS

9 SUPPLEMENTS	1
9.1 Calibrated Airspeed Conversion	2
9.2 Crosswind Component Chart	2
9.3 Placards	4
9.3.1 Cockpit Instrument Panel	4
9.3.2 Aircraft Standards	7
9.3.3 Fuselage	9
9.3.7 Positioning Diagram	11
9.4 Weight and Balance Calculation Template	15
9.5 Center of Gravity Form	17
9.6 Flight Training Supplement	18
9.7 Improvements and Corrections	19
9.8 Continued Operational Safety Reporting	19
9.9 Owner Change of Address Notice	21

T1-POH-13	PAGE	Rev. Date
Revision: NC	9-1	11/14/2024

9.1 Calibrated Airspeed Conversion

See figure 9.1.1 below for the calibrated airspeed vs indicated airspeed conversion.

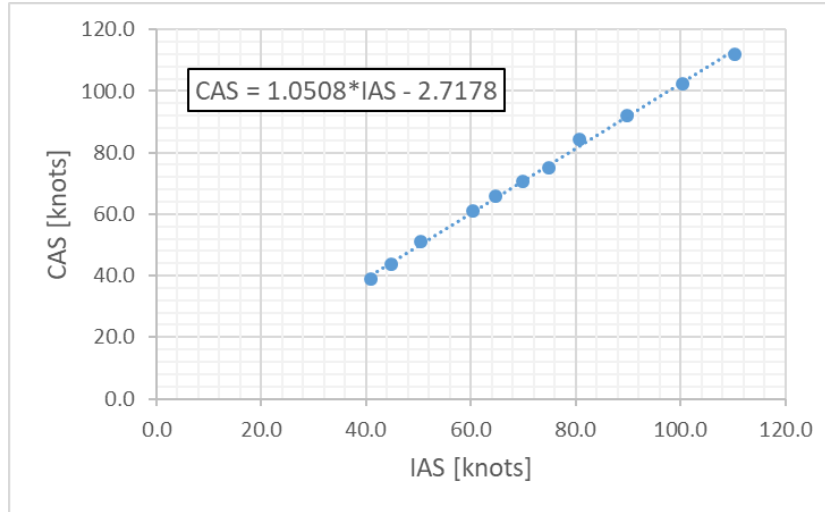

Figure 9.1.1 Calibrated vs Indicated Airspeeds

9.2 Crosswind Component Chart

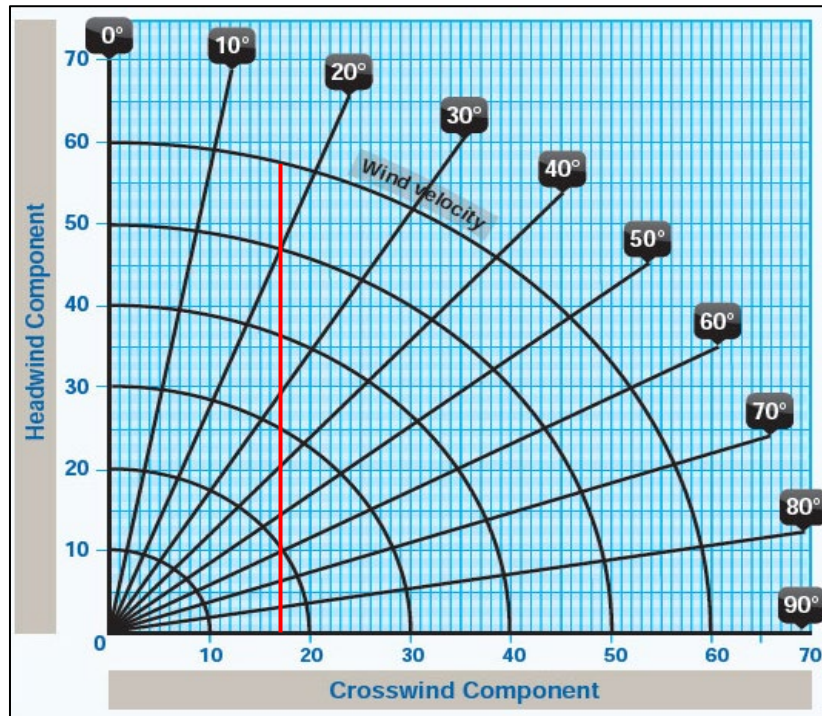

Figure 9.2.1 Crosswind Component Chart

T1-POH-13	PAGE	Rev. Date
Revision: NC	9-2	11/14/2024

9.3 Placards

9.3.1 Cockpit Instrument Panel

Panel Lights

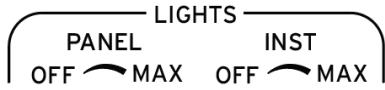

Alternator

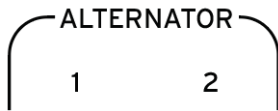

The label for the second alternator is included only when equipped with the second alternator.

EFIS Reversionary



The label is included only when equipped with the second screen with MFD display.

Auto Pilot

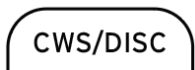
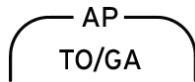

Flap

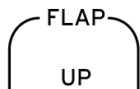

USB Charger



Com Transmit (Dynon)

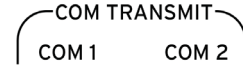

The label is included only when equipped with the second radio.

EFIS Data USB (Dynon)



Voltage Outlet

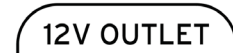

The label is included only when equipped with a 12 voltage outlet.

Microphone plug

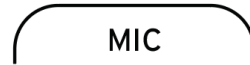

Phone plug



6 pins plug

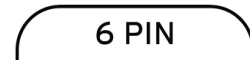

Carburetor Heat Control Knob

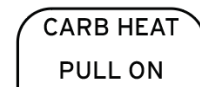

The label is included if equipped with carburetor heat.

Choke Control Knob

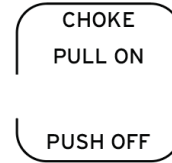

Master Switches

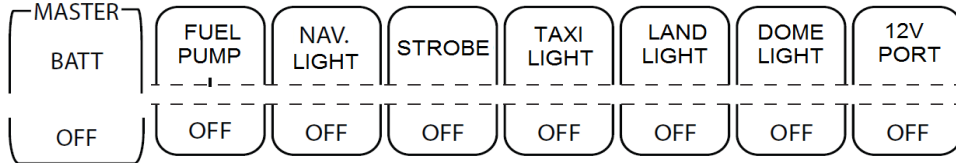

Master Buss 1

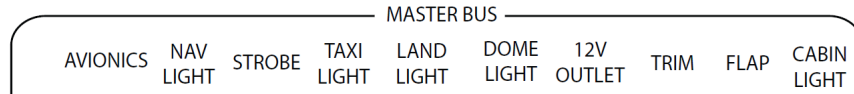

The label may change according to the panel model.

Master Buss 2

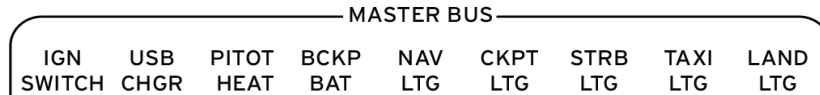

The label may change according to the panel model.

Avionics Buss

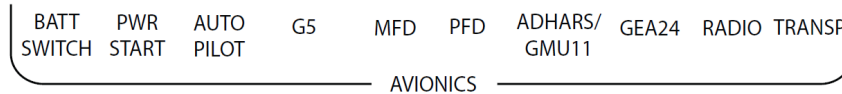

The label may change according to the panel model.

Switches

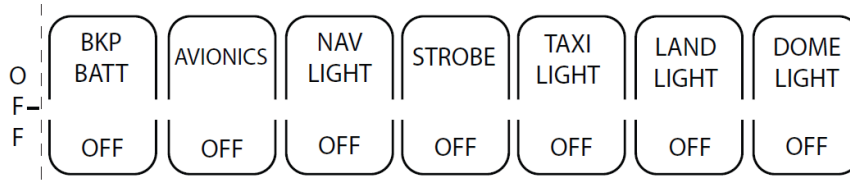

The label may change according to the panel model.

9.3.2 Aircraft Standards

Kinds of Operation

FLIGHT INTO IMC IS PROHIBITED

No intentional Spins Statement

AEROBATIC MANEUVERS AND INTENTIONAL SPINS ARE PROHIBITED

THIS AIRCRAFT WAS MANUFACTURED IN ACCORDANCE WITH LIGHT SPORT AIRCRAFT AIRWORTHINESS STANDARDS AND DOES NOT CONFORM TO STANDARD CATEGORY AIRWORTHINESS REQUIREMENTS

Doors (x2 Handle and Latch)



V Speeds

AIRSPEEDS			
SPEED	DESCRIPTION	KIAS	KCAS
V _{SO}	STALL SPEED (30° - FULL FLAPS)	38	37
V _{SL}	STALL SPEED (10° - FLAPS)	40	39
V _S	STALL SPEED (0° - FLAPS)	44	44
V _X	SPEED FOR BEST ANGLE OF CLIMB	60	60
V _Y	SPEED FOR BEST RATE OF CLIMB	64	65
V _{SO}	BEST POWER-OFF GLIDE SPEED	60	60
V _{FE}	MAXIMUM FLAP EXTENDED SPEED	75	76
V _O	OPERATING MANEUVERING SPEED	87	89
V _A	DESIGN MANEUVERING SPEED		
V _{MO}	MAXIMUM STRUCTURAL CRUISING SPEED	108	111
V _{NE}	NEVER EXCEED SPEED	132	136

The speeds may change according to the propeller installed in the airplane.

Push-to-Talk (x2 Yoke)

PTT

Trim Control (x2 Yoke)

TRIM

	Colt 100	SECTION 9
	PILOT'S OPERATING HANDBOOK	SUPPLEMENTS

Throttle at console



T1-POH-13	PAGE	Rev. Date
Revision: NC	9-6	11/14/2024

9.3.3 Fuselage

Static Pressure Port on Tail Cone



Exterior Doors



ELT indication on Tail Cone



Jack Point on the bottom



Aircraft Category on the Fuselage after the Door

LIGHT SPORT

Engine Cowling – Oil Compartment

RECOMMENDED OIL

BRAND: SHELL®
 DESCRIPTION: AEROSHELL OIL SPORT PLUS 4
 SPECIFICATION: ACCORDING TO RON 424
 VISCOSITY: SAE 10 W-40
 QUANTITY: MIN. 2.5 L (0.66 US GAL)
 MAX. 3.0 L (0.8 US GAL)

Engine Cowling – Oil Compartment (exterior)



Fuselage close to Engine Cowling



9.3.4 Landing Gear Above the main landing gear fairings

NO STEP

Main Landing Gear Fairing **35 PSI**

Nose Landing Gear Fairing

25 PSI

T1-POH-13	PAGE	Rev. Date
Revision: NC	9-7	11/14/2024

9.3.5 Wing

Fuel Indication on both wings (upper)



MAX. USABLE FUEL 15.45 US GAL

Fuel Vent on both wings (lower)



Drain Indication on the bottom of both wings and bottom left side of the cowling

DRAIN



9.3.6 Control Surfaces

Aileron, Rudder, Trim and Flap Surfaces



NO PUSH

9.3.7 Positioning Diagram

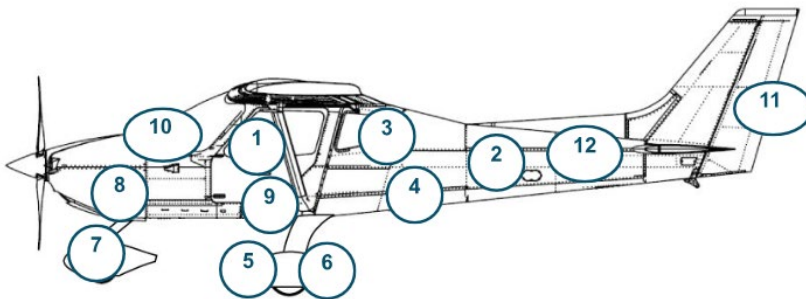
Left Side





T1-POH-13	PAGE	Rev. Date
Revision: NC	9-8	11/14/2024

ITEM	DESCRIPTION	POSITION	DESIGN
1	Doors Handle and Latch (Lock and Unlock)	Door (Inside and Outside)	
2	Static Pressure Port	Fuselage (tail)	
3	Aircraft Category - Light Sport	Fuselage near to the Door	LIGHT SPORT
4	ELT	Fuselage (tail)	
5	No Step	Main Landing Gear Fairing	NO STEP

6	35 PSI – Main Wheel Calibration	Main Landing Gear Fairing	35 PSI
7	25 PSI – Nose Wheel Calibration	Nose Landing Gear Fairing	25 PSI
8	Drain (Fuel Line – Only with Rotax 912 iS2 Sport)	Fuselage (below the door)	DRAIN 
9	Aircraft Model - Colt	Fuselage	COLT®
10	No Push	Rudder	NO PUSH
11	N-Number	Fuselage (tail)	N105TX (Sample)

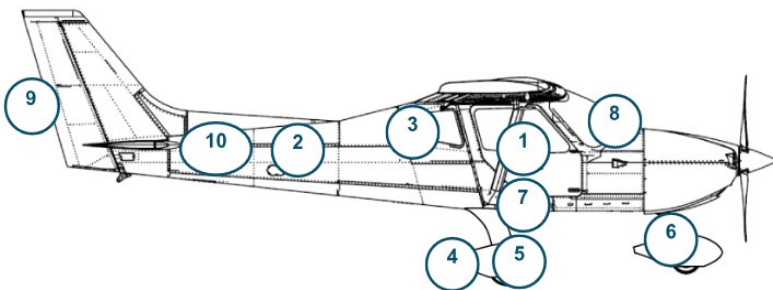
Right Side:

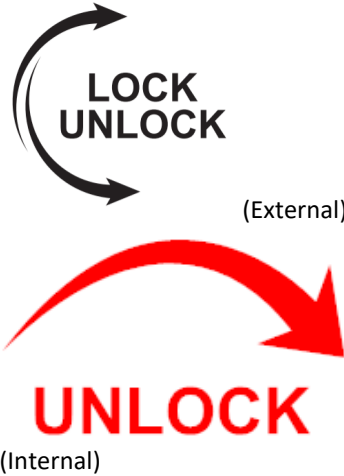

ITEM	DESCRIPTION	POSITION	DESIGN
1	Doors Handle and Latch (Lock and Unlock)	Door (Inside and Outside)	
2	Static Pressure Port	Fuselage (tail)	
3	Aircraft Category - Light Sport	Fuselage near to the Door	LIGHT SPORT
4	No Step	Main Landing Gear Fairing	NO STEP
5	35 PSI – Main Wheel Calibration	Main Landing Gear Fairing	35 PSI
6	25 PSI – Nose Wheel Calibration	Nose Landing Gear Fairing	25 PSI

	Colt 100	SECTION 9
	PILOT'S OPERATING HANDBOOK	SUPPLEMENTS

7	Drain (Fuel Line – Only with Rotax 912 iS2 Sport)	Fuselage (below the door)	DRAIN 
8	Aircraft Model - Colt	Fuselage	COLT®
9	No Push	Rudder	NO PUSH
10	N-Number	Fuselage (tail)	N105TX (Sample)

NOTE

The above placard colors are subject to change depending on exterior and interior color schemes.

T1-POH-13	PAGE	Rev. Date
Revision: NC	9-12	11/14/2024

9.4 Weight and Balance Calculation Template

Item	Weight [lbs]	Arm [in]	Moment
Empty Aircraft*			
Fuel		86.50	
Pilot		82.99	
Passenger		82.99	
Baggage		107.99	
Totals		SEE BELOW	
$CG\ (in) = \frac{total\ moment\ (in)}{total\ weight\ (in)}$		CG Inches _____	
$\%CG = \frac{(CG - LE)}{c} * 100$		CG % _____	

*See the Weight and Balance Form to obtain the correct empty weight and balance report.

The CG is within the CG range of 75.86 inches (20.85%) and 80.51 inches (29.32%). A Weight and Balance Loading Form for flight can be found in Section 9 Supplements.

	Colt 100	SECTION 9
	PILOT'S OPERATING HANDBOOK	SUPPLEMENTS

9.5 Center of Gravity Form

Below is the CG data for the Colt 100. The pilot must use the information provided below to guarantee the correct weight and balance calculation before each flight. This is essential for a safe flight.

Serial Number	TXA004
Registration Number	N657BW
W _{MLG} [lb]	765.00
W _{NLG} [lb]	123.459
W _{empty} [lb]	888.46
CG [in]	75.45
CG [%]	20.14%



 Texas Aircraft Manufacturing INC

T1-POH-13	PAGE	Rev. Date
Revision: NC	9-14	11/14/2024

	Colt 100	SECTION 9
	PILOT'S OPERATING HANDBOOK	SUPPLEMENTS

9.6 Flight Training Supplement

A Flight Training Supplement is a separate document and must be supplied by Texas Aircraft Manufacturing. The Supplement contains the basic flight and maneuvers applicable to this aircraft.

Manual: T1-FTS-REV

Note: Rev means the effective revision, such as NC, A, B, etc.

T1-POH-13	PAGE	Rev. Date
Revision: NC	9-15	11/14/2024

	Colt 100	SECTION 9
	PILOT'S OPERATING HANDBOOK	SUPPLEMENTS

9.7 Improvements and Corrections

 Feedback Form
<p>Owner/Operator: Contact Information: Aircraft S/N: Aircraft Registration Number: Date:</p> <p><i>The aircraft's owner or maintainer should use this form to contact the manufacturer by e-mail for improvements, corrections, safety of flights and/or service difficulty issues identified during the operation of the aircraft or in the contents of this manual.</i></p>

Texas Aircraft Manufacturing, INC
508 Vandenberg Road, Hangar 5
Hondo, TX 78861
800-922-2161
www.texasaircraft.com
support@texasaircraft.com

9.8 Continued Operational Safety Reporting

Contact Texas Aircraft Manufacturing to report possible safety of flight and service difficulty issues (faults, malfunctions, defects, and other occurrences) upon discovery using the Feedback Form in Section 9.7 above. Please send the mentioned form by mail or email to:

Texas Aircraft Manufacturing, INC
508 Vandenberg Road, Hangar 5
Hondo, TX 78861
800-922-2161
www.texasaircraft.com
support@texasaircraft.com

T1-POH-13	PAGE	Rev. Date
Revision: NC	9-16	11/14/2024

	Colt 100	SECTION 9
	PILOT'S OPERATING HANDBOOK	SUPPLEMENTS

The owner/operator has the responsibility to understand that they may submit written comments and questions regarding any mandatory notice issued by Texas Aircraft Manufacturing by using the Feedback Form in Section 9.7 and sending an email with the form to support@texasaircraft.com.

T1-POH-13	PAGE	Rev. Date
Revision: NC	9-17	11/14/2024

	Colt 100	SECTION 9
	PILOT'S OPERATING HANDBOOK	SUPPLEMENTS

9.9 Owner Change of Address Notice

Please, in case of a change in ownership, address, email and/or phone number, inform Texas Aircraft Manufacturing by mail or email to:

Texas Aircraft Manufacturing, INC
508 Vandenberg Road, Hangar 5
Hondo, TX 78861
800-922-2161
www.texasaircraft.com
support@texasaircraft.com

Please note that the owner/operator shall be responsible for providing Texas Aircraft Manufacturing with current contact information where the manufacturer may send the owner/operator supplemental notification bulletins.

T1-POH-13	PAGE	Rev. Date
Revision: NC	9-18	11/14/2024